

General Catalogue . Главный Каталог

MINIPRESS s.r.l.
40050 CASTELLO D'ARCILE (BO) - ITALY . VIA L. EINAUDI, 11
TEL. +39.051.6869070 . FAX +39.051.977842 . INFO@MINIPRESS.IT . WWW.MINIPRESS.IT

MINIPRESS
DIAGNOSTIC SYSTEMS

Лучше профилактика чем ремонт.

Компания Минипресс создана в 1991 году с целью решения проблем и мониторинга в контроле давления гидравлических систем.

После большого опыта в данной отрасли, Дарио Корси, создатель компании решил найти выход для эффективной работы машинной отрасли с гидравлическими системами.



Dario e Davide Corsi

производителям гидравлики реализую один из самых точных приборов в мире.

Качественное функционирование особенно дорогих и сложных машин могло быть остановлено банальным препятствием, уменьшением или изменением давления масел. Выход, который он нашёл может и не сложный но и не так уж лёгок – диагностика, которая может гарантировать в любой момент и в любом месте, а так же в любых условиях быструю проверку техники в работающей системе. За более чем 20 лет, Минипресс удалось дать гарантию

Система Минипресс предлагает наивысшую гарантию и качество, уверенность в результате и длительность в работе в всех системах где используется точка измерения давления. И именно это даёт возможность диагностировать, контролировать и предвидеть любые неисправности вашей техники.

Prevention is better than cure. The Mini Press philosophy.

Mini Press aim and mission, ever since it was founded in 1991, has been one and one only: solving the problem of pressure control and monitoring fluids inside hydraulic systems.

After a life long experience in the field, Mr Dario Corsi, the company founder, decided to tackle one of the most common causes of mobile machineries inefficiency: the proper functioning of even the most complex and expensive machines could be thwarted or hindered by a sudden and simple reduction or change in the fluid pressure. The most obvious solution to this problem, but not the simplest, was to create a specific testing system that would allow the immediate control of the pressure inside the machine, without stopping its functioning, at any moment of the working process, in any place, or under any conditions (even the most extreme).

In almost twentyfive years of activity, Mini Press has been able to establish itself as one of the major and most qualified producers of hydraulic testing equipment in the world. All of this was achieved through hard work at refining and improving its testing system, and by catching the attention and finding favour with the most attentive and significant manufacturing companies. Mini Press testing method, devised in-house, guarantees efficiency, safety and endurance for all the machines to which it is installed at construction.

If prevention is always better than cure, Mini Press products and diagnostic testing method are excellent for avoiding any future malfunctioning and expensive repairs and at the same time they can increase the quality and the performance of your machines.

Качество, эффективность и быстрые поставки.

Новое управление Компании Минипресс находится в Кастелло ди Арджиле возле Болоньи, в самом сердце итальянской гидравлики. Здесь вы сможете найти высокую технологию и качество, которые именно сегодня так необходимы в работе.

Удовлетворить клиента это наша постоянная цель. И поэтому сегодня те кто нас знает, видят в нас не только хорошего производителя но и партнёра, на которого можно всегда положиться.

Quality, efficiency and speed in supplying.

Mini Press new "headquarters" are based in Castello d'Argile, in the Emilia region, the heart of the Italian "hydraulic valley". The new location is equipped with the latest technologies for production and the highest quality control. All of this, along with the experience gained over the years, enables Mini Press to offer products and service valued worldwide. Customer's satisfaction has always been our main aim and whoever knows us is well aware that not only are we excellent producers of pressure testing systems but above all Mini Press is a true business partner, on whom one can always rely on.



MINIPRESS
DIAGNOSTIC SYSTEMS

“Rapid System” лучшая система в диагностике гидравлических систем.

Со всем своим опытом и **“Rapid system”**, которым располагает, Минипресс реализовал полную гамму компонентов которая позволяет мониторинг каждой системы. Локализируя немедленно проблему и не позволяя возникнуть новым сложностям **“Rapid system”** может быть использован в тестировании в выпуске воздуха, в сборе масел на анализ, в сервисе и ремонте без отключения системы от работы. Эта система позволяет экономить время и ресурсы и даёт гарантии пользователю. Это единственная система позволяющая точный контроль гидравлики увеличивая тем самым ценность техники на которой она установлена.

“Rapid System”, the most perfect diagnostic system for hydraulic plants.

With all its experience and know-how, Mini Press created and finely tuned **“Rapid System”**, a complete range of miniaturized components which allow a constant monitoring and immediate control on any hydraulic equipment. By localizing immediately any problem in the system it avoids any further complications. **“Rapid System”** can be used at any time during the phases of testing, bleeding, fluid sampling, maintenance and assistance, without stopping the functioning of the plant. Thus reducing the amount of time and resources spent on servicing the machines, and at the same time further insures the operators' safety.

“Rapid System” is the only solution that enables a reliable and effective control of hydraulics plants and at the same time increases the intrinsic value of the machine to which it is installed.

В распоряжение мира производителей.

Продукция и системы Минипресс могут быть установлены на любой технике. Сеть реализации может гарантировать поставки в любую сферу : сельское хозяйство, промышленность, строительство и транспорт в любой точке мира. Отношение цена/качество нашей продукции может гарантировать уверенность и качество всем пользователям.

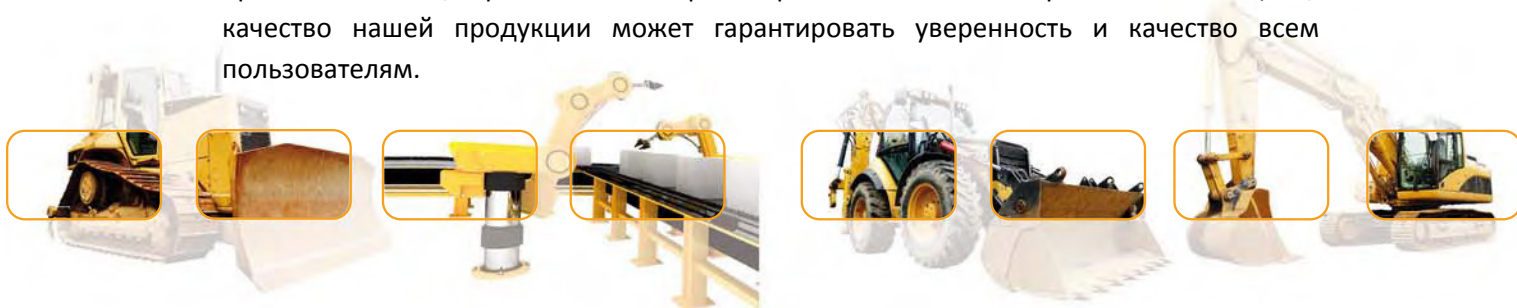

At the Manufacturer's service.

Mini Press products and systems can be applied to any type of mobile machine. With our comprehensive distribution network, we can supply everywhere in the world, in all the main sectors: agricultural, industrial, building construction or transport and in each sector the manufacturer can increase the quality and safety of their machines, thanks to the amazing cost/benefits ratio of our products.

Наша продукция Our products.



Точки измерения давления

Test couplings for pressure control



Микротрубки высокого давления и фиттинги

High pressure micro-hose and fittings



Сжим для трубок

Digital instruments for Pressure testing



Переносные инструменты контроля давления

Portable pressure test kits



Манометры

Pressure gauges



Краны для защиты манометров

Anti-shock valves for gauges protection



Расходомеры

High pressure in-line flow indicators

Минипресс в мире

Минипресс поставляет и сотрудничает с компаниями во всех самых важных точках гидравлического мира: Аргентина, Бельгия, Австралия, Чили, Китай, Дания, Дубай, Египет, Франция, Германия, Англия, Греция, Индия, Ирландия, Исландия, Израиль, Ливан, Новая Зеландия, Голландия, Польша, Португалия, Чешская республика, Болгария, Россия, Скандинавские страны, Словакия, Испания, Америка, ЮАР, Швейцария, Тунис, Турция и т.д.

Mini Press Worldwide.

Mini Press supply products and assistance to its customers in the main markets around the World, directly or through appointed agents and distributors:

Argentina, Australia, Austria, Belgium, Bulgaria, Chile, Czech Republic, Denmark, Dubai, Egypt, France, Germany, Great Britain, Greece, Holland, Iceland, India, Ireland, Israel, Lebanon, New Zealand, Poland, Portugal, Romania, Russia, Scandinavia, Slovakia, Slovenia, Spain, South Africa, Switzerland, U.S.A, Tunisia, Turkey.

- 2 **Точки контроля давления**
Test couplings for pressure checking



- 16 **Шланги высокого давления малого сечения и прессуемая арматура**
Micro hose for high pressure and fittings



- 35 **Электронный инструмент измерения и контроля**
Digital instruments for pressure testing



- 37 **Портативные переносные наборы**
Portable hydraulic instruments for pressure testing



- 39 **Манометры механические**
Pressure gauges



- 40 **Анти-шок вентиль для защиты манометров от гидроударов**
Pressure gauge anti-shock valves



- 42 **Индикаторы для одновременного измерения рабочего давления, количества потока и температуры рабочей жидкости**
High pressure in-line flow indicators





Применение:

- Контроль давления
- Системы централизованной смазки
- Пневматика
- Гидравлические системы сервоуправления

Материалы:

Карбоновая сталь с гальваническим покрытием
(Нержавеющая сталь по запросу)

Уплотнения:

NITRILE BUNA N (NBR)
(VITON, по запросу)
Рабочие температуры:
-30°C...+125°C (NITRILE BUNA N)
-25°C...+230°C (FKM)

Жидкости:

Гидравлические масла
Минеральные масла
Пригодность к другим жидкостям по запросу

Applications:

- Pressure control
- Lubrification
- Air bleeding
- Oil sampling

Materials:

Galvanised carbon steel
(Stainless steel AISI 316 is available on request)

Sealing:

NITRILE BUNA N (NBR)
FKM – VITON (on request)
Working temperature:
-30°C...+125°C (NITRILE BUNA N)
-25°C...+230°C (FKM)

Fluids:

Hydraulic oils
Mineral oils
Suitability with other fluids on request

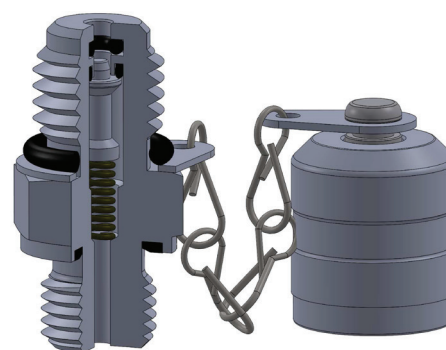

Размер отверстий по типу резьбы и уплотнению

Hole screw-cuts and sealing types

Тип **A**

Уплотнение по резьбе резиновое кольцо O-Ring sealing	G	D	L	L1
M 8x1		9.5	11	15.5
M 10x1		11.5	12	16.5
M 10x1.25		11	12	16.5
M 14x1.5		15.8	12	18

Тип **B**

Уплотнение специальной кромкой металл по металлу Metal sealing edge	G	Dmin	Lmin	L1min	Smax
M 8x1		13	8	10	1
M 10x1		15	10	13.5	1
M 12x1.5		18	12	18.5	1
M 14x1.5		20	14	18.5	1
M 16x1.5		22	14	18.5	1.5
M 18x1.5		25	12	15	2
M 20x1.5		27	14	17	2
M 22x1.5		28	14	17	2.5
M 27x1.5		33	16	20	2.5
ISO 228 G 1/8"		15	10	13.5	1
ISO 228 G 1/4"		19	14	18.5	1
ISO 228 G 3/8"		24	16	18.5	1.5
ISO 228 G 1/2"		28	14	18	2.5
ISO 228 G 3/4"		33	16	20	2.5

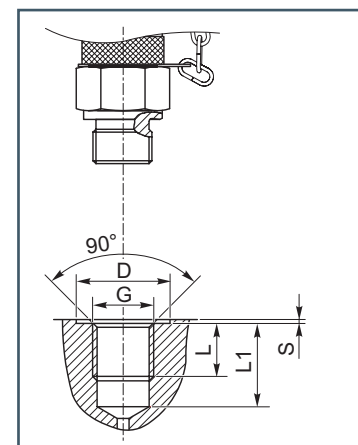
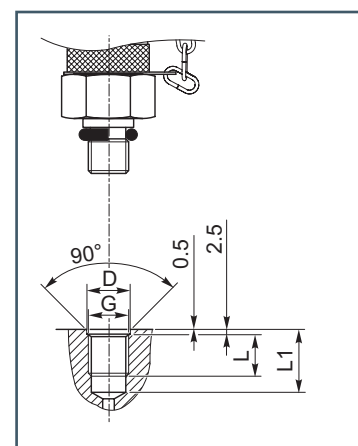



Точки контроля давления
Test couplings for pressure checking



Тип **C**

Уплотнение по прилегающей плоскости резиновым кольцом
Flat gasket sealing

G	D	L	L1	S
M 10x1	17	10	13.5	1
M 10x1,25	17	10	13.5	1
M 12x1.5	18	12	18.5	1
M 14x1.5	20	14	18.5	1
M 16x1.5	22	14	18.5	1.5
ISO 228 G 1/8"	17	10	13.5	1
ISO 228 G 1/4"	20	14	18.5	1
ISO 228 G 3/8"	24	16	18.5	1.5
ISO 228 G 1/2"	30	18	24	1.5

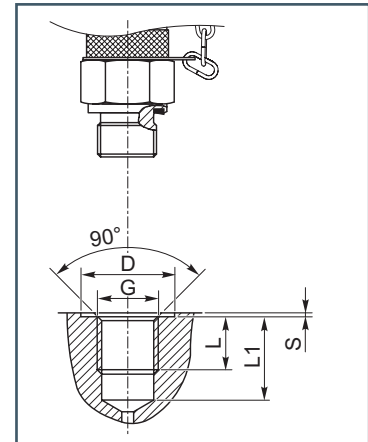

Тип **D**

Выдержка / Seal:
- Газовая коническая ISO 7/1
- Резьба NPTF
Самоуплотняющаяся резьба:
- B.S.P. коническая ISO 7/1

Sealing by thread:
- B.S.P. Taper ISO 7/1
- Taper NPTF

G	L	L1
ISO 7/1 1/8"	5.5	12
ISO 7/1 1/4"	8.5	13.5
ISO 7/1 3/8"	12	20
1/8"-27 NPTF	9	14
1/4"-18 NPTF	9	18.5
3/8"-18 NPTF	14	20
1/2"-14 NPTF	18	24

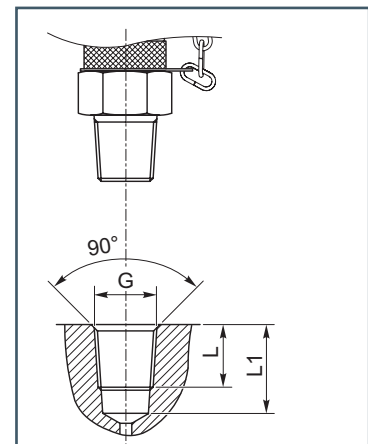

Тип **E**

Уплотнение по резьбам UNF

UNF O-Ring sealing

G	d	D	L	L1	S	a
5/16"-24 UNF	9,2	15	11	14	2.4	1.6
3/8"-24 UNF	10,6	16	11	14	2.4	1.6
7/16"-20 UNF	12.4	17	11.5	14	2.4	1.6
1/2"-20 UNF	14	18	11.5	14	2.4	1.6
9/16"-18 UNF	15.6	20	12.7	15.5	2.5	1.6
3/4"-16 UNF	20.5	25	16	20	2.6	2.4

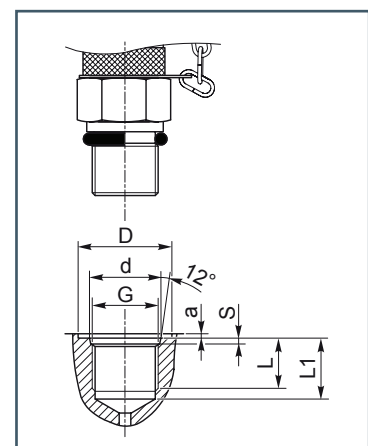



Как заказать

How to order

Вы можете указать цифровой код продукции согласно таблице и буквенное обозначение желаемого исполнения

Please indicate the code shown in the required form chart, and add, if necessary, the letter of the chosen option.

Форма / Form

Металлический колпачок с цепочкой и сферическим уплотнением
Metal cap with chain and ball sealing system

Убрать "S1" в коде / Delete "S1" in the ref. XxxxxxxxC

Колпачок : буква "C" в коде / "C" in the ref. XxxxxxxxC

Металлический колпачок с цепочкой и распределенной системой уплотнения
Metal cap with chain and poppet valve sealing system

буква "S1" в коде / Put "S1" in the ref. S1xxxxxxxC

Колпачок : буква "C" в коде / "C" in the ref. S1xxxxxxxC

Опции / Options



O

Металлическая крышка с пластиковым держателем / Metal cap with plastic binder

В конце кода заменить "C" на O / Replace "C" with "O" xxxxxxxO



P

Пластиковая крышка с пластиковым держателем / Plastic cap

В конце кода заменить "C" на P / Replace "C" with "P" xxxxxxxP

Точка контроля давления M16x2 с уплотнением по резьбе

Threaded test couplings M16x2

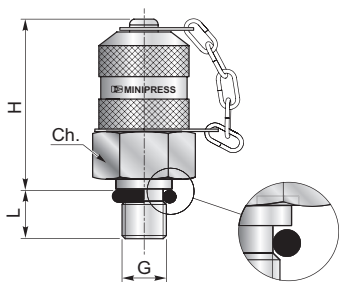

G	H	L	Ch	PN [bar]	Выдержка / Seal	Код/Ref.
Цилиндрическое измерение / Metric parallel						
M8x1	37	8.5	17	250	O-Ring Type A	S10108X10C
M10x1	37	8.5	17	630		S10110X10C
M10x1.25	37	9	17	630		S10110X12C
M14x1.5	37	10	19	630		S10114X15C
Цилиндрическое измерение / Metric parallel						
7/16"-20UNF	37	9	17	630	O-Ring Type E	S10171X20C
1/2"-20UNF	37	10	17	630		S10112X20C
9/16"-18UNF	37	10	19	630		S10191X18C
3/4"-16UNF	37	14	22	630		S10134X16C
5/16"-24UNF	37	9	17	630		S10151X24C
3/8"-24UNF	37	9	17	630		S10138X24C

Опции/Options

O

P



Точки контроля давления
Test couplings for pressure checking



Точка контроля давления M16x2 с торцевым уплотнением

Threaded test couplings M16x2

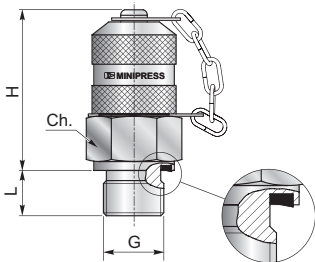

G	H	L	Ch	PN [bar]	Выдержка / Seal	Код/Ref.
Цилиндрическое измерение / Metric parallel						
M 10x1	37	8	17	630	Type C	S10410X10C
M 10x1.25	37	8	17	630		S10410X12C
M 12x1.5	37	10	17	630		S10612X15C
M 14x1.5	37	12	19	630		S10614X15C
M 14x1.5 *	37	12	22	630		S10614X15AIC
M16x1.5	37	12	22	630		S10616X15C
Цилиндрическое измерение / B.S.P. parallel						
ISO 228 G 1/8"	37	8	17	630	Type C	S10718G00C
ISO 228 G 1/8" *	37	8	17	630		S10718GAIC
ISO 228 G 1/4"	37	12	19	630		S10714G00C
ISO 228 G 1/4" *	37	12	19	630		S10714GAIC
G 1/4" BS5200	37	11	19	630		S10714B00C
ISO 228 G 3/8"	37	14	22	630		S10738G00C
ISO 228 G 1/2"	37	15	27	630		S10712G00C
ISO 228 G 1/2" *	37	15	27	630		S10712GAIC

* нержавеющая сталь /
Stainless steel

Опции/Options

O P

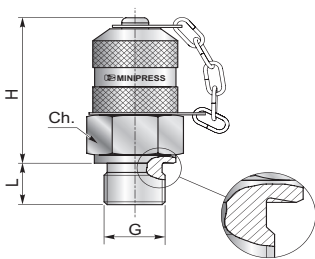

G	H	L	Ch	PN [bar]	Выдержка / Seal	Код/Ref.
Цилиндрическое измерение / Metric parallel						
M 8X1	37	8	17	630	Type B	S10308X10C
M 10X1	37	8.5	17	400		S10310X10C
M 12X1.5	37	12	17	630		S10312X15C
M 14X 1.5	37	12	19	630		S10314X15C
M 16X1.5	37	12	22	630		S10316X15C
M 18X1.5	37	12	27	630		S10318X15C
M 20X1.5	37	12	27	630		S10320X15C
M 22X1.5	37	14	27	630		S10322X15C
M 27X1.5	37	16	32	630		S10327X15C
Цилиндрическое измерение / BSP parallel - Форма Б / Form B						
ISO 228 G 1/8"	37	8	17	400	Type B	S10418G00C
ISO 228 G 1/4"	37	12	19	630		S10414G00C
ISO 228 G 3/8"	37	14	22	630		S10438G00C
ISO 228 G 3/4"	37	12	32	630		S10434G00C
ISO 228 G 1/2"	37	14	27	630		S10412G00C

Опции/Options

O P

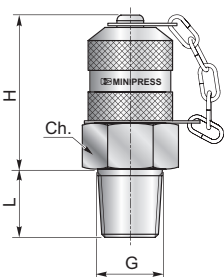

G	H	L	Ch	PN [bar]	Выдержка / Seal	Код/Ref.
измерение конуса / B.S.P taper						
ISO 7/1 R 1/8"	37	10	17	400	Type D	S10818280C
ISO 7/1 R 1/4"	37	12	19	630		S10814190C
ISO 7/1 R 1/4"	37	12	19	630		S1081419AIC
ISO 7/1 R 3/8"	37	14	22	630		S10838190C
NPTF / NPTF						
1/8"-27 NPTF	37	10	17	400	Type D	S10918270C
1/4"-18 NPTF	37	17	17	630		S10914180C
1/4"-18 NPTF*	37	17	17	630		S1091418AIC
3/8"-18 NPTF	37	16	22	630		S10938180C
1/2"-14 NPTF	37	17	24	630		S10912140C
1/2"-14 NPTF*	37	17	24	630		S1091214AIC
1/4"-18 NPTF	37	14	17	630		S10914150C

* нержавеющая сталь /
Stainless steel

O P



Точка контроля давления M16x1.5 с уплотнением по резьбе

Threaded test couplings M 16x1.5

M16x1.5

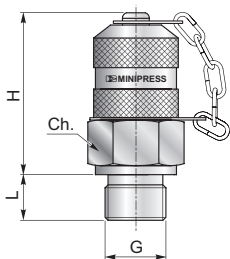

G	H	L	Ch	PN [bar]	Выдержка/Seal	Код/Ref.
Цилиндрическое измерение / Metric parallel						
M 8x1	37	8.5	17	250	O-Ring Type	S10108150C
M 10x1	37	8.5	17	630	A	S10110150C
Цилиндрическое измерение / B.S.P. parallel						
ISO 228 G 1/4"	37	12	19	630	Type	S10714150C
ISO 228 G 1/8"	37	8	17	630	C	S10718150C
M 14X1.5	37	12	19	630		S10614150C
7/16"-20UNF	37	9	17	630	O-Ring Type	S10171X20150C
					E	

Точка контроля давления S12.65x1.65 с уплотнением по резьбе

Threaded test couplings S12.65x1.65

S12.65x1.65

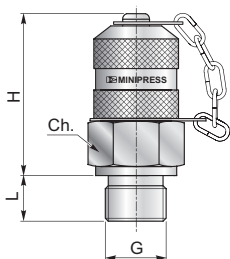

G	H	L	Ch	PN [bar]	Выдержка/Seal	Код/Ref.
Цилиндрическое измерение / Metric parallel						
M 8x1	30	8.5	14	250	O-Ring Type	S10108120C
M 10x1	30	8.5	14	630	A	S10110120C
Цилиндрическое измерение / B.S.P. parallel						
ISO 228 G 1/4"	29	8	19	630	O-Ring Type	S10714120C
M 10X1	37	8	17	630	C	S10410X10120C
ISO 228 G 1/8"	37	8	17	630		S10718120C



Точки контроля давления
Test couplings for pressure checking



Резьбовое тестовое соединение

Threaded test couplings M 16x2

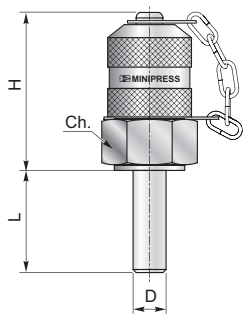

D	H	L	Ch	PN [bar]		Код/Ref.
				Series L	Series S	
6	37	20	17	315	630	S11206000C
6*	37	20	17	315	630	S11206A10C
8	37	20	17	315	630	S11208000C
10	37	20	17	315	630	S11210000C
12	37	20	17	315	630	S11212000C
14	37	20	17	—	630	S11214000C
15	37	20	17	315	—	S11215000C
16	37	20	17	—	400	S11216000C

*Нержавеющая сталь /
Stainless steel

Опции/Options



Точка контроля давления через перегородку

Bulkhead test coupling M 16x2

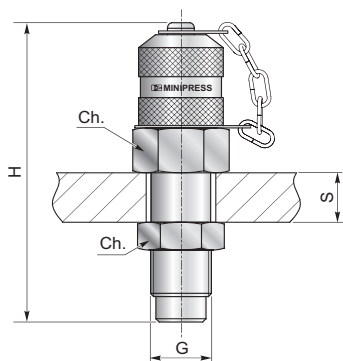

G	H	Ch	S max	PN [bar]	Код/Ref.
M 16x2	80	19	25	630	S122PP000C

Опции/Options



Точка контроля давления через перегородку с подключением для металлических труб с врезным кольцом

Bulkhead test coupling for metal pipe fitting M 16x2

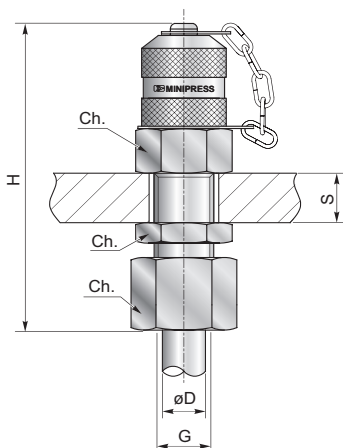

Serie / Series	D	G	H	Ch	Ch 1	S max	PN [bar]	Код/Ref.
S	8	M 16x1.5	80	19	19	20	630	S11616X15C
	10	M 18x1.5	82	22	22	20	630	S11618X15C
	12	M 20x1.5	84	24	24	20	630	S11620X15C

Опции/Options



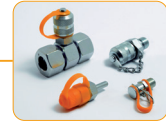

Линейное трубное соединение с врезными кольцами и встроенной точкой контроля давления
Straight test coupling for metal pipe fitting

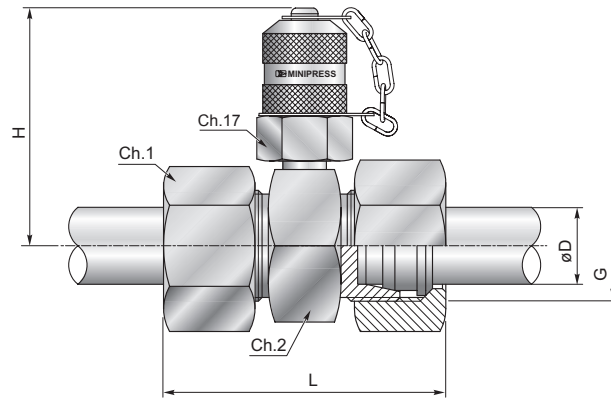

Serie / Series	D	G	H	L	Ch 1	Ch 2	PN [bar]	Код/Ref.	Код/Ref.	Код/Ref.
кольцевые соединители / Ring fittings								M16x2	M16x1.5	S12.65x1.65
L	6	M 12x1.5	49	51	14	24	315	S1130600C	S11306150C	S11306120C
	8	M 14x1.5	49	51	17	24	315	S1130800C	S11308150C	S11308120C
	10	M 16x1.5	49	53	19	24	315	S1131000C	S11310150C	S11310120C
	12	M 18x1.5	49	53	22	24	315	S1131200C	S11312150C	S11312120C
	15	M 22x1.5	50.5	55	27	27	315	S1131500C	S11315150C	S11315120C
	18	M 26x1.5	53	57	32	32	315	S1131800C	S11318150C	S11318120C
	22	M 30x2	53	61	36	32	160	S1132200C	S11322150C	S11322120C
	28	M 35x2	57.5	61	41	41	160	S1132800C	S11328150C	S11328120C
	35	M 45x2	60	69	50	46	160	S1133500C	S11335150C	S11335120C
	42	M 52x2	64.5	71	60	55	160	S1134200C	S11342150C	S11342120C
S	6	M 14x1.5	49	55	17	24	630	S1140600C	S11406150C	S11406120C
	8	M 16x1.5	49	55	19	24	630	S1140800C	S11408150C	S11408120C
	10	M 18x1.5	49	57	22	24	630	S1141000C	S11410150C	S11410120C
	12	M 20x1.5	49	57	24	24	630	S1141200C	S11412150C	S11412120C
	14	M 22x1.5	49	63	27	24	630	S1141400C	S11414150C	S11414120C
	16	M 24x1.5	52	63	30	27	400	S1141600C	S11416150C	S11416120C
	20	M 30x2	53	69	36	32	400	S1142000C	S11420150C	S11420120C
	25	M 36x2	57.5	75	46	41	400	S1142500C	S11425150C	S11425120C
	30	M 42x2	60	81	50	46	400	S1143000C	S11430150C	S11430120C
	38	M 52x2	64.5	89	60	55	315	S1143800C	S11438150C	S11438120C

Опции/Options





Точки контроля давления
Test couplings for pressure checking



Точка контроля давления с соединением типа DKO 24° с резиновым уплотнительным кольцом

Test coupling with 24° O-Ring sealing cone DKO type

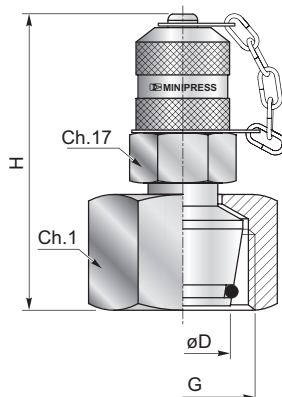

Serie / Series	D	G	H	Ch 1	PN [bar]	Код/Ref.	Код/Ref.	Код/Ref.
						M16x2	M16x1.5	S12.65x1.65
L	6	M 12x1.5	54	14	315	S11012X15C	S11012X15150C	S11012X15120C
	8	M 14x1.5	54	17	315	S11014X15C	S11014X15150C	S11014X15120C
	10	M 16x1.5	59	19	315	S11016X15C	S11016X15150C	S11016X15120C
	12	M 18x1.5	59	22	315	S11018X15C	S11018X15150C	S11018X15120C
	15	M 22x1.5	59	27	315	S11022X15C	S11022X15150C	S11022X15120C
	18	M 26x1.5	59	32	315	S11026X15C	S11026X15150C	S11026X15120C
	22	M 30x2	59	36	160	S11030X20C	S11030X20150C	S11030X20120C
	28	M 35x2	60	41	160	S11035X20C	S11035X20150C	S11035X20120C
	35	M 45x2	62	50	160	S11045X20C	S11045X20150C	S11045X20120C
42	M 52x2	65	60	160	S11052X20C	S11052X20150C	S11052X20120C	
S	6	M 14x1.5	54	17	630	S11114X15C	S11114X15150C	S11114X15120C
	8	M 16x1.5	54	19	630	S11116X15C	S11116X15150C	S11116X15120C
	10	M 18x1.5	59	22	630	S11118X15C	S11118X15150C	S11118X15120C
	12	M 20x1.5	59	24	630	S11120X15C	S11120X15150C	S11120X15120C
	14	M 22x1.5	59	27	630	S11122X15C	S11122X15150C	S11122X15120C
	16	M 24x1.5	60	30	400	S11124X15C	S11124X15150C	S11124X15120C
	20	M 30x2	62	36	400	S11130X20C	S11130X20150C	S11130X20120C
	25	M 36x2	65	46	400	S11136X20C	S11136X20150C	S11136X20120C
	30	M 42x2	65	50	400	S11142X20C	S11142X20150C	S11142X20120C
	38	M 52x2	65	60	315	S11152X20C	S11152X20150C	S11152X20120C

Опции/Options



Точка контроля давления линейная BSP 60° гайка штуцер

Check coupling male - female swivel 60°

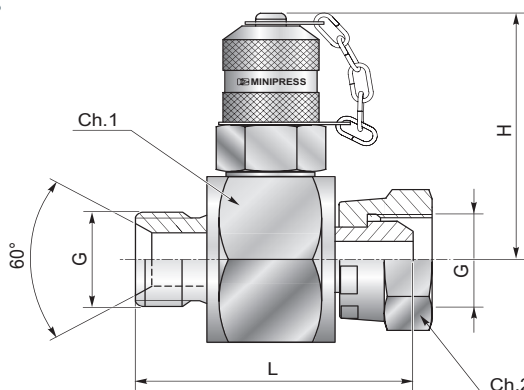

G	H	L	Ch1	Ch2	PN bar	Код/Ref.	Код/Ref.	Код/Ref.
						M16x2	M16x1.5	S12.65x1.65
ISO 228 G1/4"	55	53	32	19	400	S11914G00C	S11914150C	S11914120C
ISO 228 G3/8"	55	60	32	22	400	S11938G00C	S11938150C	S11938120C
ISO 228 G1/2"	55	60	32	27	400	S11912G00C	S11912150C	S11912120C
ISO 228 G3/4"	55	68	32	32	400	S11934G00C	S11934150C	S11934120C
ISO 228 G1"	60	74	41	41	315	S11901G00C	S11901150C	S11901120C

Опции/Options





Точка контроля давления через перегородку / подключение JIC 37°

Bulkhead test coupling - JIC 37° M 16x2

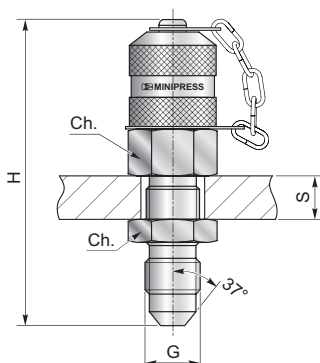

G	H	Ch	S max	PN [bar]	Код/Ref.
7/16"-20 UNF	68	17	9	630	S11707162C
1/2"-20 UNF	68	17	9	400	S11701220C
9/16"-18 UNF	69	19	9	315	S11709161C

Опции/Options



Точка контроля давления с вращающейся гайкой JIC 37°

Female swivel test coupling - JIC 37° M 16x2

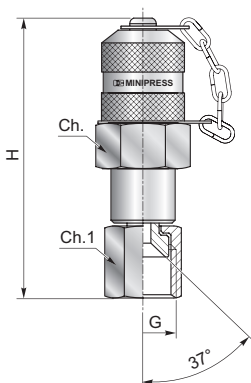

G	H	Ch	Ch 1	PN [bar]	Код/Ref.
7/16"-20 UNF	57	17	14	630	S11507163C
1/2"-20 UNF	65	17	17	400	S11512203C
9/16"-18 UNF	67	17	19	315	S11509163C
3/4"-16 UNF	70	17	22	315	S11506163C

Опции/Options



Точка контроля давления фиксирующаяся - JIC 37°

Female fixed test coupling - JIC 37° M 16x2

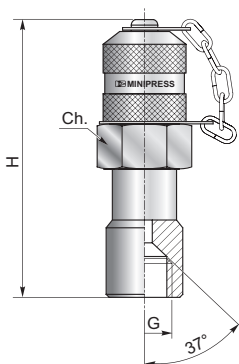

G	H	Ch	PN [bar]	Код/Ref.
7/16"-20 UNF	63	19	630	S115071FFC
1/2"-20 UNF	63	17	400	S115012FFC
9/16"-18 UNF	66	19	315	S115091FFC
9/16"-18 UNF*	66	19	315	S115091FFAIC

*Нержавеющая сталь /
Stainless steel

Опции/Options





Точки контроля давления
Test couplings for pressure checking



Точка контроля давления / присоединение ORFS

O.R.F.S female swivel test coupling M 16x2

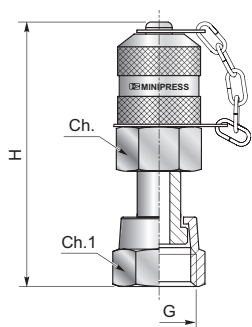

G	H	Ch	Ch 1	PN [bar]	Код/Ref.
9/16"-18 UNF	53	17	19	400	S115916FSC
11/16"-16 UNF	54	17	22	400	S115116FSC
13/16"-16 UNF	58	19	24	400	S115131FSC

Опции/Options



Точка контроля давления / присоединение BSP

Female swivel check-coupling M 16x2

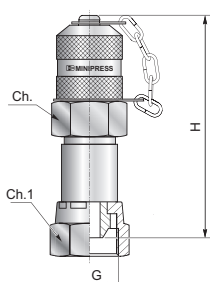

G	H	Ch	Ch 1	PN [bar]	Код/Ref.
ISO 228 G 1/4"	62	19	19	630	S115914G0C

Опции/Options



Быстро подсоединяющаяся – разъединяющаяся точка + точка измерения давления - 15Q000C

Test quick coupling + testpoint 15QC000C



Быстро подключаемая муфта, с помощью которой возможно контролировать давление в гидравлических системах, с внешней резьбой M16X2 для соединения с микрошлангом находящейся в этой системе. Заменяема с другими ISO 15171-1.

Норма: ISO 15171-1.

Применение: Диагностика в гидравлических системах.

Давление: 400 атмосфер.

Материал: сталь покрытая цинком.

Выдержка: от -30° C до +125° C.

Diagnostic quick coupling gives the opportunity to control the parameters of high-pressure oil hydraulic systems. Socket part has a minimes thread M16x2 for micro hose. Interchangeable with other ISO 15171-1.

Norm: ISO 15171-1

Application: diagnostic of hydraulic systems

Working pressure: 400 bar

Material: zinc steel

Seal: NBR (from -30°C to +125°C)



Точка контроля давления типа Plug-in Арматура для подключения стр 33

Plug-in test couplings

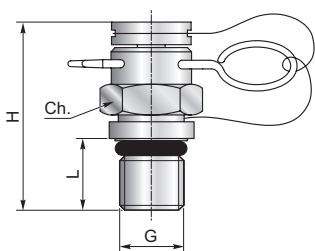

G	H	L	Ch	PN [bar]	Tenuta/Seal	Код/Ref.
Резьба цилиндра / Threaded: metric parallel (UNI 4535-64)						
M 8x1	25	8.5	12	250	O-Ring type A	51000000
M 10x1	25	8.7	14	400		51100000
ISO 228 G1/4"	25	12	19	400	Metal Sealing Edge B	5114G000

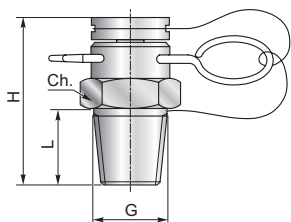

G	H	L	Ch	PN [bar]	Tenuta/Seal	Код/Ref.
Резьба конуса / Threaded: B.S.P. taper (UNI ISO 7/1)						
ISO 7/1 R1/8"	25	12	12	400	Type D	51800000
Резьба конуса / Threaded: B.S.P. taper NPTF (ANSI/ASME B.1.20.1 - 1983)						
1/8" NPTF	25	12	12	400	Type D	51900000

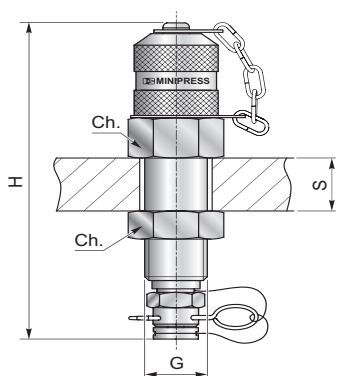

G	H	Ch	S max	PN [bar]	Код/Ref.
Точка измерения проходная / Bulkhead test coupling					
M 16x2	90	19	25	400	23PPIB0C

Опции/Options





Точки контроля давления
Test couplings for pressure checking



Точка контроля давления тип Plug-in с присоединением тип DKO 24° с резиновым кольцом

Plug-in test coupling with 24° O-Ring sealing cone DKO type

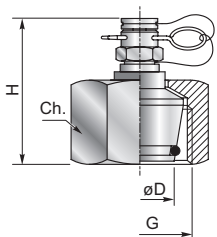

Serie / Series	D	G	H	Ch	PN [bar]	Код/Ref.
L	8	M 14x1.5	39	17	315	1014X15B
	10	M 16x1.5	39	19	315	1016X15B
	12	M 18x1.5	39	22	315	1018X15B
	15	M 22x1.5	39	27	315	1022X15B
	18	M 26x1.5	39	32	315	1026X15B
	22	M 30x2	39	36	160	1030X20B
	28	M 35x2	40	41	160	1035X20B
	35	M 45x2	42	50	160	1045X20B
S	42	M 52x2	45	60	160	1052X20B
	10	M 18x1.5	39	22	630	1118X15B
	12	M 20x1.5	39	24	630	1120X15B
	14	M 22x1.5	39	27	630	1122X15B
	16	M 24x1.5	40	30	400	1124X15B
	20	M 30x2	42	36	400	1130X20B
	25	M 36x2	44	46	400	1136X20B
	30	M 42x2	44	50	400	1142X20B
38	M 52x2	44	60	315	1152X20B	

Линейная точка контроля давления типа Plug-in встроенная в трубное соединение

Plug-in straight test coupling for metal pipe fitting

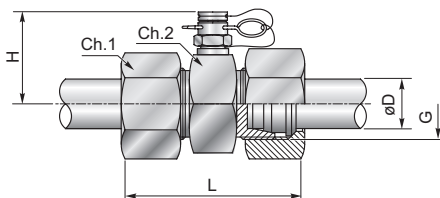

Serie / Series	D	G	H	L	Ch 1	Ch 2	PN [bar]	Код/Ref.
Кольцевые Соединители / Ring fittings								
L	6	M 12x1.5	29	51	14	24	315	1306000B
	8	M 14x1.5	29	51	17	24	315	1308000B
	10	M 16x1.5	29	53	19	24	315	1310000B
	12	M 18x1.5	29	53	22	24	315	1312000B
	15	M 22x1.5	30.5	55	27	27	315	1315000B
	18	M 26x1.5	33	57	32	32	315	1318000B
	22	M 30x2	33	61	36	32	160	1322000B
	28	M 35x2	37.5	61	41	41	160	1328000B
	35	M 45x2	40	69	50	46	160	1335000B
	42	M 52x2	44.5	71	60	55	160	1342000B
S	6	M 14x1.5	29	55	17	24	630	1406000B
	8	M 16x1.5	29	55	19	24	630	1408000B
	10	M 18x1.5	29	57	22	24	630	1410000B
	12	M 20x1.5	29	57	24	24	630	1412000B
	14	M 22x1.5	29	63	27	24	630	1414000B
	16	M 24x1.5	32	63	30	27	400	1416000B
	20	M 30x2	33	69	36	32	400	1420000B
	25	M 36x2	37.5	75	46	41	400	1425000B
	30	M 42x2	40	81	50	46	400	1430000B
	38	M 52x2	44.5	89	60	55	315	1438000B



Адаптер для манометра

Pressure gauge adapters

Как заказать
How to order

Конфигурация / Configuration

Код адаптеров всегда заканчивается 0
Adapters code ends with 0

xxxxxxx0

Опции / Options

По запросу поставляется с обратным клапаном / Pressure damper on request

S

Замените "0" на "S"
Replace "0" with "S"

xxxxxxxS

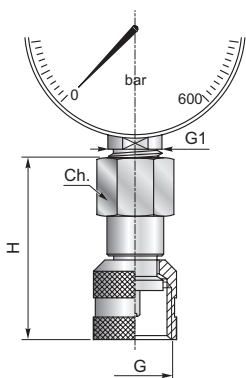

G	G1	H	Ch	PN [bar]	Код/Ref.
Носитель манометра прямого подсоединения / Direct gauge adapter					
M 16x2	ISO 228 G 1/4"	50	19	630	20140000
M 16x2*	ISO 228 G 1/4"	50	19	630	2014A100
M 16x2	ISO 228 G 1/2"	55	27	630	20120000
M 16x1.5	ISO 228 G 1/4"	50	19	630	20141500
M 16x1.5	ISO 228 G 1/2"	55	27	630	20121500
S12.65x1.65	ISO 228 G 1/4"	50	19	630	20141200
M 16x2	1/4" - 18 NPTF	50	19	630	2014NPT0

*Нержавеющая сталь /
Stainless steel

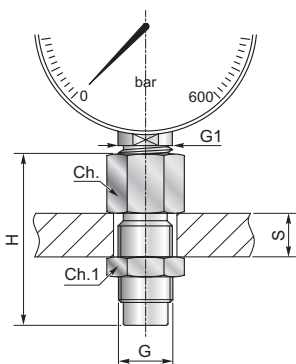

G	G1	H	Ch	Ch 1	S max	PN [bar]	Код/Ref.
Носитель манометра проходной / Bulkhead pressure gauge connection							
M 16x2	ISO 228 G 1/4"	50	19	19	11	630	18140000
M 16x2	ISO 228 G 1/2"	57	27	19	13	630	18120000
M 16x1.5	ISO 228 G 1/4"	50	19	19	11	630	18141500
S 12.65x1.65	ISO 228 G 1/4"	50	19	19	11	630	18141200
M 16x2	1/4" - 18 NPTF	50	19	19	11	630	1814NPT0

Примечание: без обратного клапана / Note: without check valve

Опции/Options

S

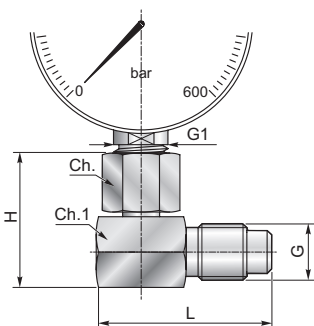

G	G1	H	L	Ch	Ch 1	PN [bar]	Код/Ref.
Носитель манометра ориентируемый на 90 / Swivel pressure gauge connection 90° angle							
M 16x2	ISO 228 G 1/4"	36	42	19	19	630	21140000
M 16x2	ISO 228 G 1/2"	43	42	27	19	630	21120000
M 16x1.5	ISO 228 G 1/4"	36	42	19	19	630	21141500
M 16x1.5	ISO 228 G 1/2"	43	42	27	19	630	21121500

Примечание: без обратного клапана / Note: without check valve

Опции/Options

S



Точки контроля давления
Test couplings for pressure checking



Адаптеры

Adapters

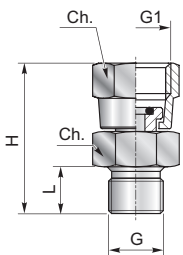

G1	G	H	L	Ch	PN [bar]	Tenuta/Seal	Код/Ref.
Соединитель носителя ориентируемого манометра на 90° / Swivel pressure gauge connection							
ISO 228 G 1/4"	ISO 228 G 1/4"	34	11	17	400	*	1814M000
ISO 228 G 1/4" **	ISO 228 G 1/4"	34	11	17	400	*	1814MA10
ISO 228 G 1/2"	ISO 228 G 1/2"	46	15	27	400	*	1812M000
ISO 228 G 1/2"	ISO 228 G 1/4"	50	13	27	400	*	1812M140
ISO 228 G 1/8"	ISO 228 G 1/4"	36.5	14	19	400	*	1814M700
ISO 228 G 1/4"	ISO 7/1 R 1/4"	34	12	17	400	*	1814MBSPT
ISO 228 G 1/2"	ISO 7/1 R 1/2"	46	16	27	400	*	1812MBSPT
ISO 228 G 1/2"	ISO 7/1 R 1/4"	46.5	12	22	400	*	1824MBSPT
ISO 228 G 1/2"	ISO 228 G 3/8"	49.5	12	27	400	*	1812M380

* Нержавеющая сталь (по запросу) / Copper washer (on request)
** Нержавеющая сталь / Stainless steel

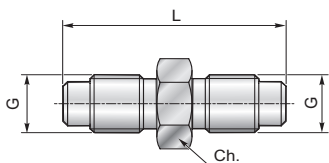

G	L	Ch	PN [bar]	Код/Ref.
Адаптер прямой для микро шлангов. Проход свободный / Straight adapter for connection of hoses. Free flow.				
M 16x2	43	17	630	40GD0000
M 16x1.5	43	17	630	40GD1500

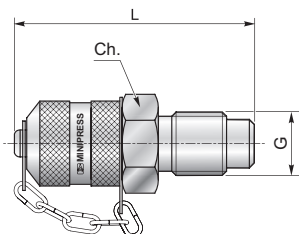

G	L	Ch	PN [bar]	Код/Ref.
Адаптер прямой с невозвратным клапаном / Straight adapter with no-return valve				
M 16x2	53	17	630	41GV000C

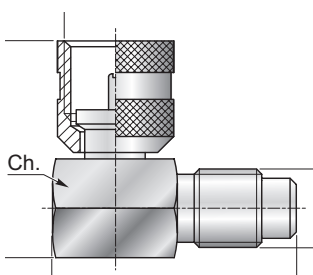

G	H	L	Ch	PN [bar]	Код/Ref.
Адаптер ориентируемый на 90° / 90° Swivel adapter					
M 16x2	42	41	19	630	24GG0000
M 16x1.5	42	41	19	630	24GG1500



Как заказать готовый шланг в сборе

How to order

Пример заказа
 Ordering example

Codice ordine / Order code					
RD2	31TN	0	3614	0	L1500
1	2	3	4	5	6

- 1 Тип-размер шланга / Hose type
- 2 Тип первого фитинга / Fitting type
- 3 Угол изгиба фитинга
Elbow fitting angle
- 4 Тип второго фитинга
Fitting type
- 5 Угол разворота в случае если два фитинга угловые
Elbow fitting angle
- 6 Длина шланга / Hose length

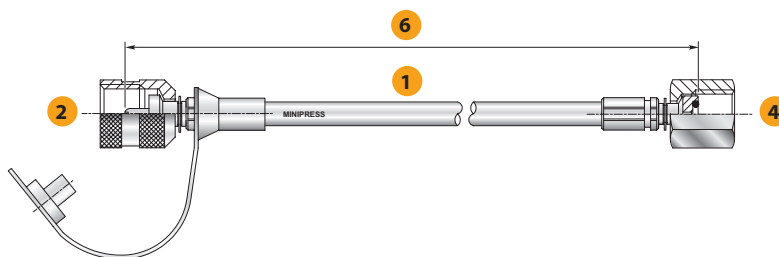
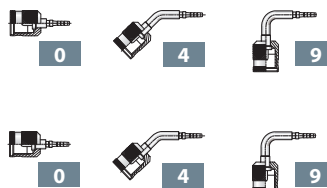

На основании правил

Reference regulations

шланг Код / Hose code				
RD2 - RD3 - RD4				
Химическая стойкость к тормозным жидкостям (DOT 4) минеральным и гидравлическим маслам, бензину For mineral and hydraulic oil, type ASTM 3. fuel. Brake systems oil (type DOT 4).				
		RD2	RD3	RD4
Внешний диаметр Outside diameter	[mm]	5	6	8
Внутренний диаметр Inside diameter	[mm]	2	3	4
Рабочее давление Max. working pressure	[bar]	630	500	500
Разрывное давление Min. bursting pressure	[bar]	1890	1890	1500
Радиус изгиба Min. bending radius	[mm]	20	25	35
Рабочая температура Working temperature	°C	-40...+100	-40...+100	-40...+100
Внутренняя трубка Core material	Полиэстер термопластик Thermoplastic polyester			
Армирующая оплетка Braid material	Кевларовая нить Aramidic fibre			
Внешнее покрытие Cover material	Абразивостойкий полиуретан Antibrasion polyurethane			



Шланги малого сечения (капилляры) высокого давления и прессуемая арматура
Micro hose for high pressure and fittings



Колпачок пылезащиты для соединителей RD2 и RD4 F16X2, 16X1,5, S12,65X1,65 и штык
Anti-dust plastic cap suitable for RD2 and RD4 F16X2, 16X1,5, S12,65X1,65 and plug-in fittings

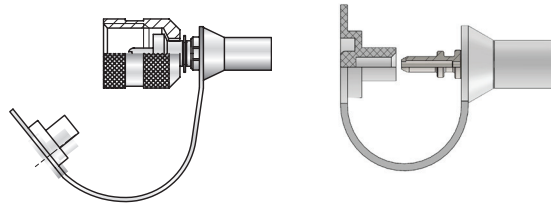

Код/Ref.
 32CP0000
 32CP0004

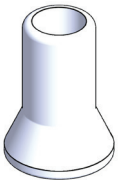

Колпачок пыли защиты для соединителей RD2 и RD4
Ferrules anti-dust cap for RD2 and RD4 fittings

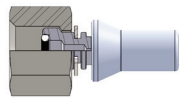

Код/Ref.
 32CS0000
 32CS0004

Капиллярные трубки RD2 и RD4 оснащены колпачками пылезащиты 32CP000X и / или 32CS000X. В случае приобретения отдельно соединителей, 32CP000X и / или 32CS000X уже включены в код соединителя.
Fitted micro hoses RD2 and RD4 are always complete with anti-dust caps 32CP000X and/or 32CS000X. In case of purchase of loose fittings, 32CP000X and/or 32CS000X are included in fitting part number.

Фитинги для подключения к точкам контроля давления

Test coupling threaded female fitting

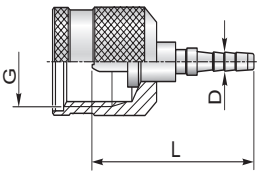

Шланг / Hose	G	L	D	Код/Ref.
RD2	M16x2	32.5	2.0	31TTN000
	M16x2*	32.5	2.0	31TNAI00
	M16x1.5	32.5	2.0	31TTS000
	S12.65x1.65	32.5	2.0	31S12000
RD3	M16x2	37.2	3.0	31TTN003
	M16x1.5	37.2	3.0	31TTS003
	S12.65x1.65	37.2	3.0	31S12003
RD4	M16x2	36.5	4.0	31TTN004
	M16x2*	36.5	4.0	31TNAI04
	M16x1.5	36.5	4.0	31TTS004
	S12.65x1.65	36.5	4.0	31S12004

*Нержавеющая сталь /
 Stainless steel

45°

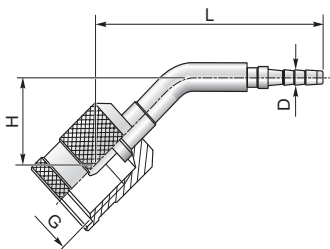

Шланг / Hose	G	L	H	D	Код/Ref.
RD2	M16x2	48	18	2.0	31TTN040
	M16x1.5	48	18	2.0	31TTS040
	S12.65x1.65	48	18	2.0	31S12040
RD3	M16x2	48	18.5	3.0	31TTN043
	M16x1.5	48	18.5	3.0	31TTS043
	S12.65x1.65	48	18.5	2.0	31S12043
RD4	M16x2	53	18.5	4.0	31TTN044
	M16x1.5	53	18.5	4.0	31TTS044
	S12.65x1.65	53	18.5	4.0	31S12044

90°

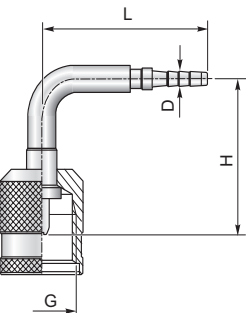

Шланг / Hose	G	L	H	D	Код/Ref.
RD2	M16x2	34.5	31.0	2.0	31TTN090
	M16x1.5	34.5	31.0	2.0	31TTS090
	S12.65x1.65	34.5	31	2.0	31S12090
RD3	M16x2	34.5	31.0	3.0	31TTN093
	M16x1.5	34.5	31.0	3.0	31TTS093
RD4	S12.65x1.65	34.5	31	3.0	31S12093
	M16x2	34.5	31.0	4.0	31TTN094
	M16x1.5	34.5	31.0	4.0	31TTS094
	S12.65x1.65	34.5	31	4.0	31S12094



Фитинги для подключения к точкам контроля давления

Test coupling threaded female fitting with hexagonal nut

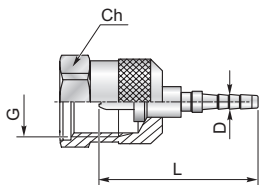

Шланг / Hose	G	L	Ch	D	Код/Ref.
RD2	M16x2	32.5	19	2.0	31TTN600
	M16x2*	32.5	19	2.0	31TTN6A1
	M16x1.5	32.5	19	2.0	31TTS600
RD3	M16x2	37.2	19	3.0	31TTN603
	M16x1.5	37.2	19	3.0	31TTS603
RD4	M16x2	36.5	19	4.0	31TTN604
	M16x1.5	36.5	19	4.0	31TTS604

*Нержавеющая сталь /
Stainless steel

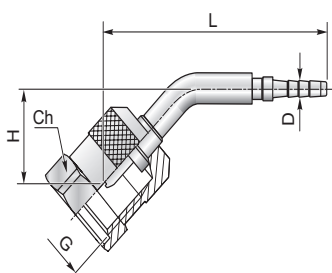

45°						
Шланг / Hose	G	L	H	Ch	D	Код/Ref.
RD2	M16x2	48	18	19	2.0	31TTN640
	M16x1.5	48	18	19	2.0	31TTS640
RD3	M16x2	48	18.5	19	3.0	31TTN643
	M16x1.5	48	18.5	19	3.0	31TTS643
RD4	M16x2	53	18.5	19	4.0	31TTN644
	M16x1.5	53	18.5	19	4.0	31TTS644

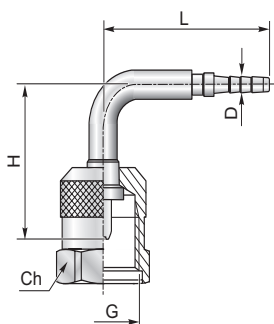

90°						
Шланг / Hose	G	L	H	D	Код/Ref.	
RD2	M16x2	34.5	31	2.0	31TTN690	
	M16x1.5	34.5	31	2.0	31TTS690	
RD3	M16x2	34.5	31	3.0	31TTN693	
	M16x1.5	34.5	31	3.0	31TTS693	
RD4	M16x2	34.5	31	4.0	31TTN694	
	M16x1.5	34.5	31	4.0	31TTS694	



Шланги малого сечения (капилляры) высокого давления и прессуемая арматура
Micro hose for high pressure and fittings



Фитинги для подключения манометров
Gauges threaded fitting

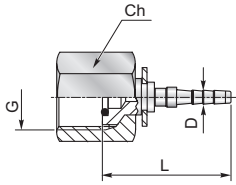

Шланг / Hose	G	L	Ch	D	Код/Ref.
RD2	G 1/4	26	19	2.0	36140000
	G 1/4 *	26	19	2.0	3614A100
	G 1/2	33.5	27	2.0	36120000
	M20X1.5	33.5	24	2.0	36M2OR00
RD3	G 1/4	30	19	3.0	3614OR03
	G 1/2	37.5	27	3.0	3612OR03
	M20X1.5	37.5	24	3.0	36M2OR03
RD4	G 1/4	36.5	19	4.0	3614OR04
	G 1/2	37.3	27	4.0	3612OR04
	M20X1.5	37.3	24	4.0	36M2OR04

*Нержавеющая сталь /
Stainless steel

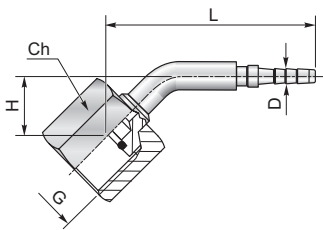

45°						
Шланг / Hose	G	H	L	Ch	D	Код/Ref.
RD2	G 1/4	14.0	47.0	19	2.0	36140040
	G 1/2	21.0	54.5	27	2.0	36120040
	M20X1.5	21.0	54.5	24	2.0	36M2OR40
RD3	G 1/4	14.0	47.0	19	3.0	3614OR43
	G 1/2	21.0	54.5	27	3.0	3612OR43
	M20X1.5	21.0	54.5	24	3.0	36M2OR43
RD4	G 1/4	14.0	52.0	19	4.0	3614OR44
	G 1/2	21.0	59.5	27	4.0	3612OR44
	M20X1.5	21.0	59.5	24	4.0	36M2OR44

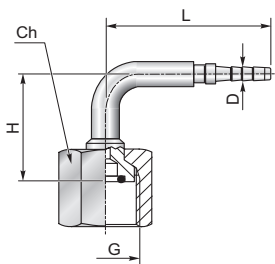

90°						
Шланг / Hose	G	H	L	Ch	D	Код/Ref.
RD2	G 1/4	25.0	38.0	19	2.0	36140090
	G 1/2	37.5	41.5	27	2.0	36120090
	M20X1.5	37.5	41.5	24	2.0	36M2OR90
RD3	G 1/4	25.0	38.0	19	3.0	3614OR93
	G 1/2	37.5	41.5	27	3.0	3612OR93
	M20X1.5	37.5	41.5	24	3.0	36M2OR93
RD4	G 1/4	25.0	43.0	19	4.0	3614OR94
	G 1/2	37.5	46.5	27	4.0	3612OR94
	M20X1.5	37.5	46.5	24	4.0	36M2OR94



Фитинги для подключения манометров

Gauges threaded fitting

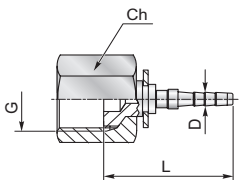

Шланг / Hose	G	L	Ch	D	Код/Ref.
RD2	G 1/4	26	19	2.0	3614CR00
	G 1/2	33.5	27	2.0	3612CR00
	M20X1.5	33.5	24	2.0	36M2CR00
RD3	G 1/4	30	19	3.0	3614CR03
	G 1/2	37.5	27	3.0	3612CR03
	M20X1.5	37.5	24	3.0	36M2CR03
RD4	G 1/4	36.5	19	4.0	3614CR04
	G 1/2	37.5	27	4.0	3612CR04
	M20X1.5	36.5	24	4.0	36M2CR04

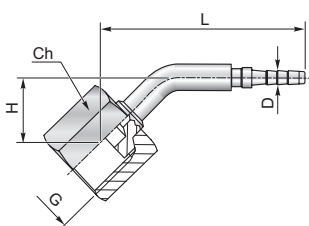

45°						
Шланг / Hose	G	H	L	Ch	D	Код/Ref.
RD2	G 1/4	14	47	19	2.0	3614CR40
	G 1/2	21	54.5	27	2.0	3612CR40
	M20X1.5	21	54.5	24	2.0	36M2CR40
RD3	G 1/4	14	47	19	3.0	3614CR43
	G 1/2	21	54.5	27	3.0	3612CR43
	M20X1.5	21	54.5	24	3.0	36M2CR43
RD4	G 1/4	14	52	19	4.0	3614CR44
	G 1/2	21	59.5	27	4.0	3612CR44
	M20X1.5	21	59.5	24	4.0	36M2CR44

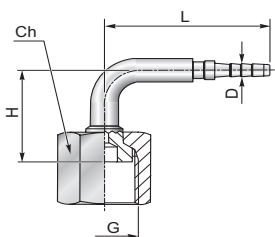

90°						
Шланг / Hose	G	H	L	Ch	D	Код/Ref.
RD2	G 1/4	25	38	19	2.0	3614CR90
	G 1/2	37.5	41.5	27	2.0	3612CR90
	M20X1.5	37.5	41.5	24	2.0	36M2CR90
RD3	G 1/4	25	38	19	3.0	3614CR93
	G 1/2	37.5	41.5	27	3.0	3612CR93
	M20X1.5	37.5	41.5	24	3.0	36M2CR93
RD4	G 1/4	25	43	19	4.0	3614CR94
	G 1/2	37.5	46.5	27	4.0	3612CR94
	M20X1.5	37.5	46.5	24	4.0	36M2CR94



Шланги малого сечения (капилляры) высокого давления и прессуемая арматура
Micro hose for high pressure and fittings



Фитинги для подключения манометров
Gauges threaded fitting

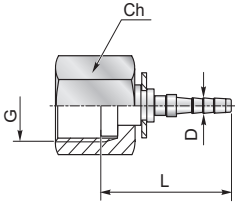

Шланг / Hose	G	L	Ch	D	Код/Ref.
RD2	G 1/8	22.6	14	2.0	4918DF00
	G 1/4	23.5	17	2.0	4914DF00
RD3	G 1/8	26.6	14	3.0	4918DF03
	G 1/4	27.5	17	3.0	4914DF03
RD4	G 1/8	26.6	14	4.0	4918DF04
	G 1/4	27.5	17	4.0	4914DF04

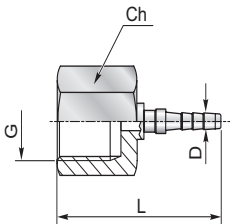

Шланг / Hose	G	L	Ch	D	Код/Ref.
RD2	1/4-18 NPTF	30	19	2.0	37140000
RD3	1/4-18 NPTF	34	19	3.0	37140003
RD4	1/4-18 NPTF	34	19	4.0	37140004

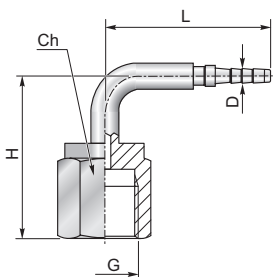

90°						
Шланг / Hose	G	H	L	Ch	D	Код/Ref.
RD2	1/4-18 NPTF	28.5	36	19	2.0	37140090
RD3	1/4-18 NPTF	28.5	36	19	3.0	37140093
RD4	1/4-18 NPTF	28.5	36	19	4.0	37140094



Фитинг с гайкой и уплотняющим конусом 60° тип DKR / (BSP)

Swivel female fitting 60° cone connection type DKR

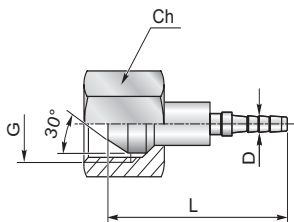

Шланг / Hose	G	L	Ch	D	Код/Ref.
RD2	G 1/8	24	14	2.0	38180000
	G 1/4	26	17	2.0	38140000
	G 1/4 *	26	17	2.0	3814A100
	G 3/8	29	22	2.0	38380000
	M12x1.5	24	14	2.0	38121500
RD3	G 1/8	28	14	3.0	38180003
	G 1/4	30	17	3.0	38140003
RD4	G 1/8	31	14	4.0	38180004
	G 1/4	32.5	17	4.0	38140004

*Нержавеющая сталь /
Stainless steel

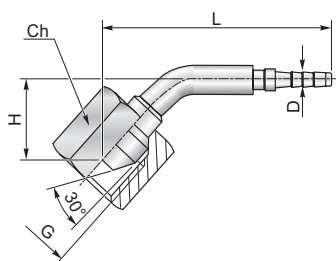

45°						
Шланг / Hose	G	H	L	Ch	D	Код/Ref.
RD2	G 1/8	15	44.5	14	2.0	38180040
	G 1/4	16	47.5	17	2.0	38140040
RD3	G 1/8	15	49.5	14	3.0	38180043
	G 1/4	16	47.5	17	3.0	38140043
RD4	G 1/8	15	49.5	14	4.0	38180044
	G 1/4	16	52.5	17	4.0	38140044

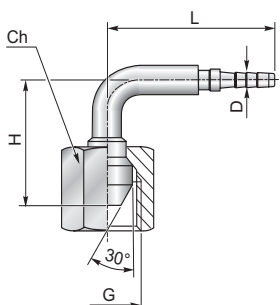

90°						
Шланг / Hose	G	H	L	Ch	D	Код/Ref.
RD2	G 1/8	26	34	14	2.0	38180090
	G 1/4	27.5	36.5	17	2.0	38140090
RD3	G 1/8	26	39	14	3.0	38180093
	G 1/4	27.5	36.5	17	3.0	38140093
RD4	G 1/8	26	39	14	4.0	38180094
	G 1/4	27.5	41.5	17	4.0	38140094



Шланги малого сечения (капилляры) высокого давления и прессуемая арматура
Micro hose for high pressure and fittings



Фитинг с гайкой и уплотняющим конусом 60° тип DKR / (BSP)

Swivel female fitting 24° cone connection type DKL

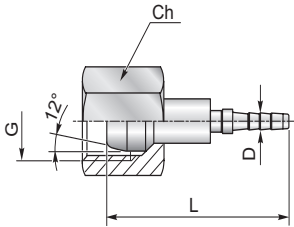

Шланг / Hose	Ø	G	L	Ch	D	Код/Ref.
RD2	6	M12x1.5	36	14	2.0	45R00000
	8	M14x1.5	35	17	2.0	45R20000
	10	M16x1.5	36.5	19	2.0	45R50000
RD3	6	M12x1.5	35	14	3.0	45R00003
	8	M14x1.5	35	17	3.0	45R20003
	10	M16x1.5	36.5	19	3.0	45R50003
RD4	6	M12x1.5	36	14	4.0	45R00004
	8	M14x1.5	36	17	4.0	45R20004
	10	M16x1.5	41.5	19	4.0	45R50004

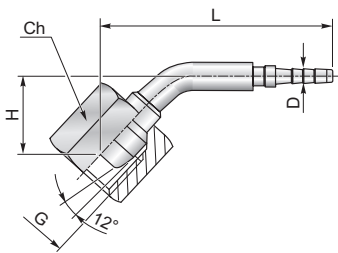

45°							
Шланг / Hose	Ø	G	H	L	Ch	D	Код/Ref.
RD2	6	M12x1.5	19.5	53.5	14	2.0	45R00040
	8	M14x1.5	19	51	17	2.0	45R20040
	10	M16x1.5	22.5	56	19	2.0	45R50040
RD3	6	M12x1.5	19.5	53.5	14	3.0	45R00043
	8	M14x1.5	19	51	17	3.0	45R20043
	10	M16x1.5	22.5	56	19	3.0	45R50043
RD4	6	M12x1.5	19.5	58.5	14	4.0	45R00044
	8	M14x1.5	19	56	17	4.0	45R20044
	10	M16x1.5	22.5	61	19	4.0	45R50044

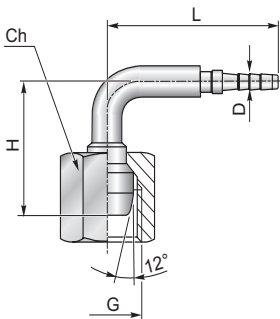

90°							
Шланг / Hose	Ø	G	H	L	Ch	D	Код/Ref.
RD2	6	M12x1.5	31.5	47.5	14	2.0	45R00090
	8	M14x1.5	36	40	17	2.0	45R20090
	10	M16x1.5	40	41.5	19	2.0	45R50090
RD3	6	M12x1.5	28.5	39	14	3.0	45R00093
	8	M14x1.5	36	40.5	17	3.0	45R20093
	10	M16x1.5	40	41.5	19	3.0	45R50093
RD4	6	M12x1.5	36	47	14	4.0	45R00094
	8	M14x1.5	36	45.5	17	4.0	45R20094
	10	M16x1.5	40	46.5	19	4.0	45R50094



Фитинг с уплотняющим конусом 24° тип DKOL (с резиновым кольцом)

Swivel female fitting 24° cone connection type DKOL

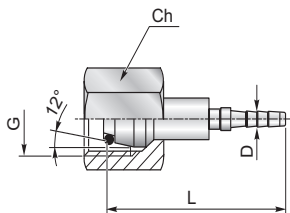

Шланг / Hose	Ø	G	L	Ch	D	Код/Ref.
RD2	6	M12x1.5	31.6	14	2.0	35R00000
	8	M14x1.5	31.6	17	2.0	35R20000
	10	M16x1.5	31.5	19	2.0	35R50000
	12	M18x1.5	34	22	2.0	35R60000
RD3	6	M12x1.5	35	14	3.0	35R00003
	8	M14x1.5	35	17	3.0	35R20003
	10	M16x1.5	36.5	19	3.0	35R50003
RD4	6	M12x1.5	35.5	14	4.0	35R00004
	6*	M12x1.5	35.5	14	4.0	35R0A104
	8	M14x1.5	36	17	4.0	35R20004
	10	M16x1.5	36.5	19	4.0	35R50004
12	M18x1.5	38	22	4.0	35R60004	

*Нержавеющая сталь /
Stainless steel

45°

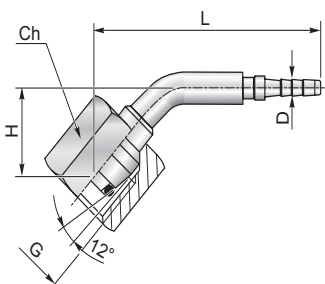

Шланг / Hose	Ø	G	H	L	Ch	D	Код/Ref.
RD2	6	M12x1.5	15	46	14	2.0	35R00040
	8	M14x1.5	19	51	17	2.0	35R20040
	10	M16x1.5	19	56	19	2.0	35R50040
RD3	6	M12x1.5	15	50	14	3.0	35R00043
	8	M14x1.5	19	51	17	3.0	35R20043
	10	M16x1.5	22.5	61	19	3.0	35R50043
RD4	6	M12x1.5	15	50	14	4.0	35R00044
	6*	M12x1.5	15	50	14	4.0	35R0A144
	8	M14x1.5	19	56	17	4.0	35R20044
	10	M16x1.5	22.5	61	19	4.0	35R50044
12	M18x1.5	22.5	61	22	4.0	35R60044	

*Нержавеющая сталь /
Stainless steel

90°

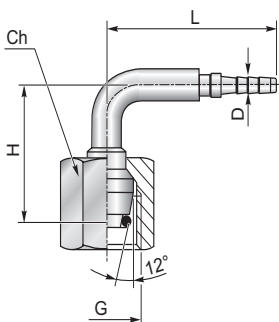

Шланг / Hose	Ø	G	H	L	Ch	D	Код/Ref.
RD2	6	M12x1.5	25	34	14	2.0	35R00090
	8	M14x1.5	36	40.5	17	2.0	35R20090
	10	M16x1.5	40	41.5	19	2.0	35R50090
RD3	6	M12x1.5	25	38	14	3.0	35R00093
	8	M14x1.5	36	40.5	17	3.0	35R20093
	10	M16x1.5	40	46.5	19	3.0	35R50093
RD4	6	M12x1.5	25	38	14	4.0	35R00094
	6*	M12x1.5	25	38	14	4.0	35R0A194
	8	M14x1.5	36	45.5	17	4.0	35R20094
	10	M16x1.5	40	46.5	19	4.0	35R50094
12	M18x1.5	40	46.5	22	4.0	35R60094	

*Нержавеющая сталь /
Stainless steel



Шланги малого сечения (капилляры) высокого давления и прессуемая арматура
Micro hose for high pressure and fittings



Фитинг с уплотняющим конусом 24° тип DKOL (с резиновым кольцом)

Swivel female fitting 24° cone connection type DKOLL

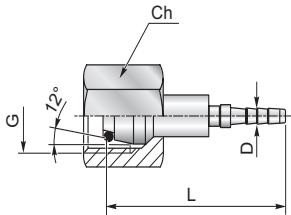

Шланг / Hose	Ø	G	L	Ch	D	Код/Ref.
RD2	4	M8x1	29.5	10	2.0	46R00000
	6	M10x1	30	12	2.0	46R10000
RD3	4	M8x1	33	10	3.0	46R00003
	6	M10x1	34	12	3.0	46R10003
RD4	4	M8x1	33	10	4.0	46R00004
	6	M10x1	34	12	4.0	46R10004

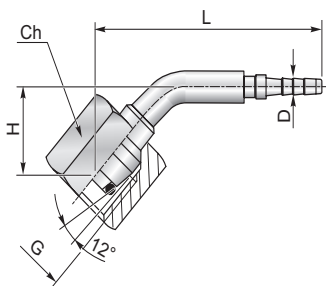

45°

Шланг / Hose	Ø	G	H	L	Ch	D	Код/Ref.
RD2	6	M10x1	15	53	12	2.0	46R10040
RD3	6	M10x1	15	57	12	3.0	46R10043
RD4	6	M10x1	15	57	12	4.0	46R10044

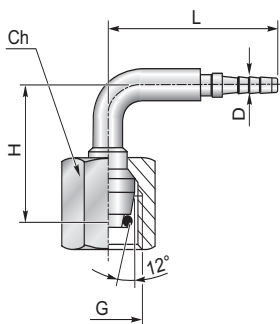

90°

Шланг / Hose	Ø	G	H	L	Ch	D	Код/Ref.
RD2	6	M10x1	28.5	39	12	2.0	46R10090
RD3	6	M10x1	28.5	43	12	3.0	46R10093
RD4	6	M10x1	24.5	47.3	12	4.0	46R10094



Фитинг с уплотняющим конусом 24° тип DKOS (с резиновым кольцом)

Swivel female fitting 24° cone connection type DKOS

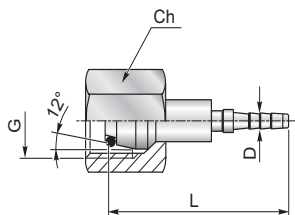

Шланг / Hose	Ø	G	L	Ch	D	Код/Ref.
RD2	6	M14x1.5	31.6	17	2.0	35R10000
	8	M16x1.5	31.6	19	2.0	35R30000
	10	M18x1.5	31.5	22	2.0	35R40000
	12	M20x1.5	34	24	2.0	35R70000
RD3	6	M14x1.5	35	17	3.0	35R10003
	8	M16x1.5	35	19	3.0	35R30003
	10	M18x1.5	36.5	22	3.0	35R40003
RD4	6	M14x1.5	35.5	17	4.0	35R10004
	8	M16x1.5	36	19	4.0	35R30004
	10	M18x1.5	36.5	22	4.0	35R40004

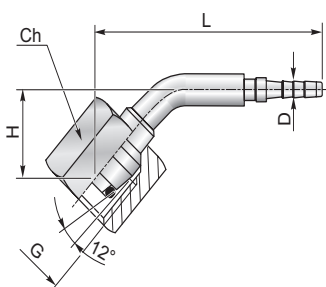

45°							
Шланг / Hose	Ø	G	H	L	Ch	D	Код/Ref.
RD2	6	M14x1.5	14.5	43	17	2.0	35R10040
	8	M16x1.5	19	51	19	2.0	35R30040
	10	M18x1.5	19	56	22	2.0	35R40040
RD3	6	M14x1.5	14.5	50	17	3.0	35R10043
	8	M16x1.5	19	51	19	3.0	35R30043
	10	M18x1.5	22.5	61	22	3.0	35R40043
RD4	6	M14x1.5	14.5	50	17	4.0	35R10044
	8	M16x1.5	19	56	19	4.0	35R30044
	10	M18x1.5	22.5	61	22	4.0	35R40044
	12	M20x1.5	22.5	61	24	4.0	35R70044

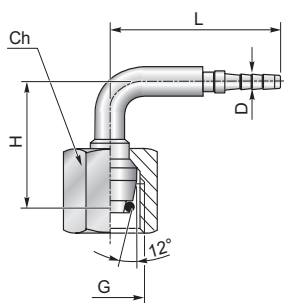

90°							
Шланг / Hose	Ø	G	H	L	Ch	D	Код/Ref.
RD2	6	M14x1.5	24.5	34.5	17	2.0	35R10090
	8	M16x1.5	36	40.5	19	2.0	35R30090
	10	M18x1.5	40	41.5	22	2.0	35R40090
RD3	6	M14x1.5	24.5	38.5	17	3.0	35R10093
	8	M16x1.5	36	40.5	19	3.0	35R30093
	10	M18x1.5	40	46.5	22	3.0	35R40093
RD4	6	M14x1.5	24.5	38.5	17	4.0	35R10094
	8	M16x1.5	36	45.5	19	4.0	35R30094
	10	M18x1.5	40	46.5	22	4.0	35R40094
	12	M20x1.5	40	46.5	24	4.0	35R70094



Шланги малого сечения (капилляры) высокого давления и прессуемая арматура
Micro hose for high pressure and fittings



Фитинг с внутренним уплотняющим конусом тип JIC 74°

Swivel female fitting JIC 74° connection type DKJ

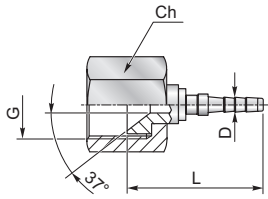

Шланг / Hose	G	L	Ch	D	Код/Ref.
RD2	7/16-20 UNF	25	14	2.0	39160000
	7/16-20 UNF*	25	14	2.0	3916A100
	1/2-20 UNF	26	17	2.0	39120000
	3/8-24 UNF	24.5	12	2.0	3938J000
	3/8-24 UNF*	24.5	12	2.0	3938JA10
RD3	7/16-20 UNF	29	14	3.0	39160003
	1/2-20 UNF	30	17	3.0	39120003
	3/8-24 UNF	27	12	3.0	3938J003
RD4	7/16-20 UNF	28	14	4.0	39160004
	7/16-20 UNF*	28	14	4.0	3916A104
	1/2-20 UNF	30	17	4.0	39120004
	3/8-24 UNF	28.5	12	4.0	3938J004

*Нержавеющая сталь /
 Stainless steel

45°

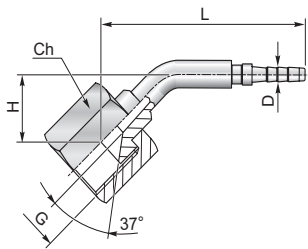

Шланг / Hose	G	H	L	Ch	D	Код/Ref.
RD2	7/16-20 UNF	13	46.5	14	2.0	39160040
	1/2-20 UNF	13	46.5	17	2.0	39120040
	3/8-24 UNF	14	46	12	2.0	3938J040
	9/16-18 UNF	15.5	54.5	17	2.0	3991J040
RD3	7/16-20 UNF	13	46.5	14	3.0	39160043
	1/2-20 UNF	13	51.5	17	3.0	39120043
RD4	7/16-20 UNF	13	51.5	14	4.0	39160044
	1/2-20 UNF	13	51.5	17	4.0	39120044
	3/8-24 UNF	14	46	12	4.0	3938J044

90°

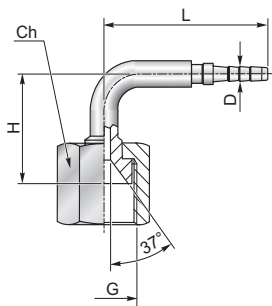

Шланг / Hose	G	H	L	Ch	D	Код/Ref.
RD2	7/16-20 UNF	23	38.5	14	2.0	39160090
	1/2-20 UNF	23	38.5	17	2.0	39120090
	3/8-24 UNF	24	40	12	2.0	3938J090
RD3	7/16-20 UNF	23	46.5	14	3.0	39160093
	1/2-20 UNF	23	43.5	17	3.0	39120093
RD4	7/16-20 UNF	23	43.5	14	4.0	39160094
	1/2-20 UNF	23	43.5	17	4.0	39120094
	3/8-24 UNF	24	40	12	4.0	3938J094



Фитинг с уплотняющей плоскостью тип ORFS ,резьба UNF

ORFS female fitting, UNF thread

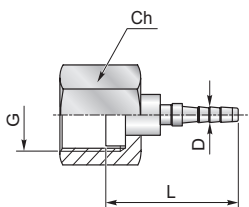

Шланг / Hose	G	L	Ch	D	Код/Ref.
RD2	9/16-18 UNF	25	17	2.0	5991F000
RD3	9/16-18 UNF	27	17	3.0	5991F003
RD4	9/16-18 UNF	31	17	4.0	5991F004

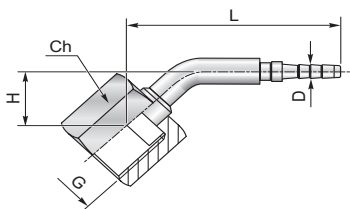

45°						
Шланг / Hose	G	H	L	Ch	D	Код/Ref.
RD2	9/16-18 UNF	13	47	17	2.0	5991F040
RD3	9/16-18 UNF	14	46	17	3.0	5991F043
RD4	9/16-18 UNF	14	46	17	4.0	5991F044

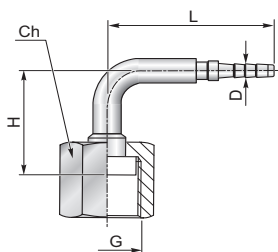

90°						
Шланг / Hose	G	H	L	Ch	D	Код/Ref.
RD2	9/16-18 UNF	24	40	17	2.0	5991F090
RD3	9/16-18 UNF	24	40	17	3.0	5991F093
RD4	9/16-18 UNF	24	40	17	4.0	5991F094



Шланги малого сечения (капилляры) высокого давления и прессуемая арматура
Micro hose for high pressure and fittings



Фитинг тип BEL/S для сборки с гайкой и врезным кольцом

Standpipe fitting

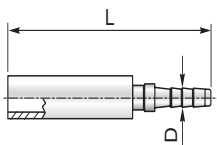

Шланг / Hose	Ø	L	D	Код/Ref.
RD2	4	36	2.0	34R70000
	6	36	2.0	34R00000
	6*	36	2.0	34R0A100
	8	36	2.0	34R30000
RD3	4	36	3.0	34R70003
	6	36	3.0	34R00003
	8	37.5	3.0	34R30003
RD4	4	41	4.0	34R70004
	6	41	4.0	34R00004
	8	41	4.0	34R30004

*Нержавеющая сталь /
Stainless steel

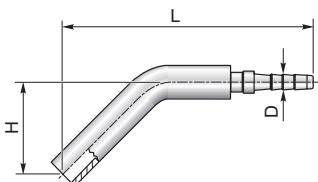

45°					
Шланг / Hose	Ø	H	L	D	Код/Ref.
RD2	4	14.5	43	2.0	34R70040
	6	16.5	44	2.0	34R00040
	8	20	52	2.0	34R30040
RD3	4	14.5	43	3.0	34R70043
	6	16.5	44	3.0	34R00043
	8	20	52	3.0	34R30043
RD4	4	14.5	48	4.0	34R70044
	6	16.5	49	4.0	34R00044
	8	20	57	4.0	34R30044

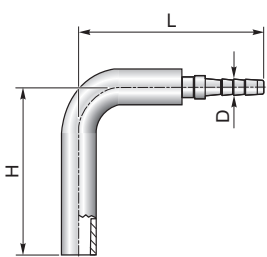

90°					
Шланг / Hose	Ø	H	L	D	Код/Ref.
RD2	4	25.5	33	2.0	34R70090
	6	28	32	2.0	34R00090
	8	37	41	2.0	34R30090
RD3	4	25.5	33	3.0	34R70093
	6	28	32	3.0	34R00093
	8	37	41	3.0	34R30093
RD4	4	25.5	38	4.0	34R70094
	6	28	37	4.0	34R00094
	8	37	46	4.0	34R30094



Фитинг тип BANJO

Banjo fitting and banjo screw

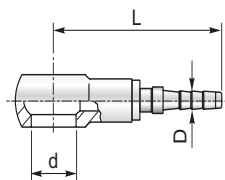

Шланг / Hose	d	Dado Forato / Banjo Screw	L	D	Код/Ref.
RD2	8	M8X1	29.5	2.0	42R10000
	10	M10X1 - G1/8	31.5	2.0	42R00000
RD3	8	M8X1	36.5	3.0	42R10003
	10	M10X1 - G1/8	31.5	3.0	42R00003
RD4	8	M8X1	34.5	4.0	42R10004
	10	M10X1 - G1/8	36.5	4.0	42R00004
	14	M14X1,5 - G1/4	40.5	4.0	42R20004

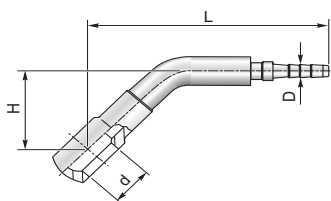

45°					
Шланг / Hose	d	H	L	D	Код/Ref.
RD2	8	22.5	45	2.0	42R10040
	10	17	51	2.0	42R00040
RD3	8	15	51.5	3.0	42R10043
	10	17	56	3.0	42R00043
RD4	8	15	51.5	4.0	42R10044
	10	17	56	4.0	42R00044

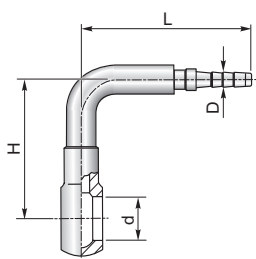

90°					
Шланг / Hose	d	H	L	D	Код/Ref.
RD2	8	26	36	2.0	42R10090
	10	36	34	2.0	42R00090
RD3	8	26	41	3.0	42R10093
	10	28	39	3.0	42R00093
RD4	8	26	41	4.0	42R10094
	10	36	40	4.0	42R00094

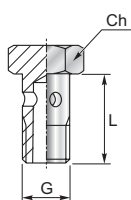

G	L	Ch	Код/Ref.
M8x1	17	12	42R0HS00
M10x1	19	14	42R1HS00
G1/8	19	14	42R18HS00



Шланги малого сечения (капилляры) высокого давления и прессуемая арматура
Micro hose for high pressure and fittings



Штуцер-фитинг с внешней резьбой

Male fittings

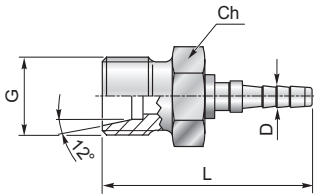

Шланг / Hose	G	L	Ch	D	Код/Ref.
RD2	M12x1.5	30	14	2.0	44MFLR00
	M14x1.5	30	17	2.0	44MFLR10
	M16x1.5	31	19	2.0	44MFLR30
RD3	M12x1.5	34	14	3.0	44MFLR03
	M14x1.5	34	17	3.0	44MFLR13
	M16x1.5	35	19	3.0	44MFLR33
RD4	M12x1.5	35	14	4.0	44MFLR04
	M14x1.5	35	17	4.0	44MFLR14
	M16x1.5	36	19	4.0	44MFLR34

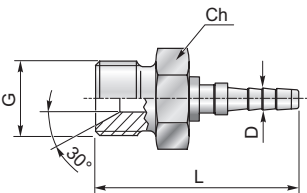

Шланг / Hose	G	L	Ch	D	Код/Ref.
RD2	G 1/8	29	14	2.0	44MFG180
	G 1/4	34	19	2.0	44MFG140
RD3	G 1/8	34.5	14	3.0	44MFG183
	G 1/4	36.5	19	3.0	44MFG143
RD4	G 1/8	37	14	4.0	44MFG184
	G 1/4	36.5	19	4.0	44MFG144
	G 3/8	42.5	22	4.0	44MFG384

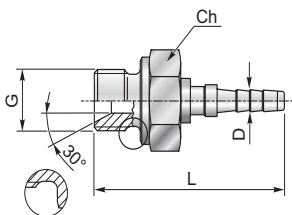

Шланг / Hose	G	L	Ch	D	Код/Ref.
RD2	G 1/8	31.5	14	2.0	44MFM180
	G 1/4	35.5	19	2.0	44MFM140
RD3	G 1/8	30.5	14	3.0	44MFM183
	G 1/4	39	19	3.0	44MFM143
RD4	G 1/8	33.5	14	4.0	44MFM184
	G 1/4	40.5	19	4.0	44MFM144

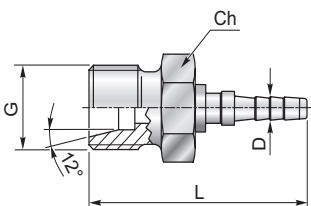

Шланг / Hose	G	L	Ch	D	Код/Ref.
RD2	M14x1.5	32	17	2.0	44MFSR00
	M16x1.5	32	19	2.0	44MFSR10
	M18x1.5	33.5	22	2.0	44MFSR20
RD3	M14x1.5	36	17	3.0	44MFSR03
	M16x1.5	36	19	3.0	44MFSR13
	M18x1.5	36.5	22	3.0	44MFSR23
RD4	M14x1.5	37	17	4.0	44MFSR04
	M16x1.5	37	19	4.0	44MFSR14
	M18x1.5	38.5	22	4.0	44MFSR24
	M20x1.5	39	24	4.0	44MFSR34



Штуцер-фитинг с внешней резьбой

Male fittings

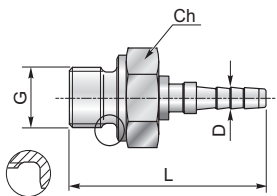

Шланг / Hose	G	L	Ch	D	Код/Ref.
RD2	M8x1	30	12	2.0	44MFDR00
	M10x1	30	14	2.0	44MFDR10
	M12x1.5	31	17	2.0	44MFDR30
	M5x1	30	12	2.0	44MFDRM5
RD3	M8x1	34	12	3.0	44MFDR03
	M10x1	34	14	3.0	44MFDR13
	M12x1.5	35	17	3.0	44MFDR33
RD4	M8x1	35	12	4.0	44MFDR04
	M10x1	35	14	4.0	44MFDR14
	M12x1.5	36	17	4.0	44MFDR34

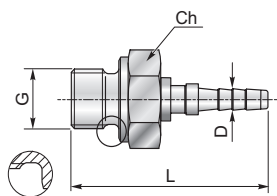

Шланг / Hose	G	L	Ch	D	Код/Ref.
RD2	G 1/8	28.5	14	2.0	44MFD180
	G 1/4	35.5	19	2.0	44MFD140
RD3	G 1/8	33.5	14	3.0	44MFD183
	G 1/4	39	19	3.0	44MFD143
RD4	G 1/8	33.5	14	4.0	44MFD184
	G 1/4	39	19	4.0	44MFD144

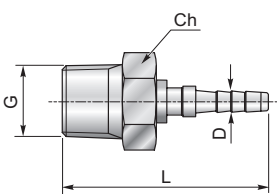

Шланг / Hose	G	L	Ch	D	Код/Ref.
RD2	R 1/8	28.5	12	2.0	44MFC180
	R 1/4	31.5	14	2.0	44MFC140
RD3	R 1/8	31.5	12	3.0	44MFC183
	R 1/4	36.5	14	3.0	44MFC143
RD4	R 1/8	31.5	12	4.0	44MFC184
	R 1/4	36.5	14	4.0	44MFC144

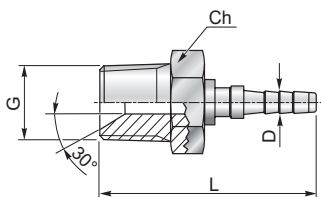

Шланг / Hose	G	L	Ch	D	Код/Ref.
RD2	1/8-27 NPTF	28	12	2.0	44MF0000
	1/4-18 NPTF	35.5	17	2.0	44MF4000
RD3	1/8-27 NPTF	33	12	3.0	44MF8003
	1/4-18 NPTF	38	17	3.0	44MF0003
RD4	1/8-27 NPTF	35	12	4.0	44MF8004
	1/4-18 NPTF	40.5	17	4.0	44MF0004



Шланги малого сечения (капилляры) высокого давления и прессуемая арматура
Micro hose for high pressure and fittings



Штуцер-фитинг с внешней резьбой UNF тип ORFS

ORFS male fitting, UNF thread

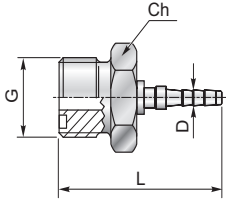

Шланг / Hose	G	L	Ch	D	Codice/Ref.
RD2	9/16-18 UNF	29	17	2.0	5991M000
RD3	9/16-18 UNF	33	17	3.0	5991M003
RD4	9/16-18 UNF	33	17	4.0	5991M004

Штуцер-фитинг с внешней резьбой UNF тип JIC 74°

JIC 74° Male fittings

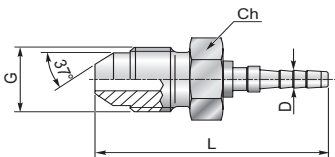

Шланг / Hose	G	L	Ch	D	Код/Ref.
RD2	3/8-28 UNF	32	12	2.0	44AJ3800
	7/16-20 UNF	34.5	14	2.0	44AJ7100
	1/2-20 UNF	37	17	2.0	44AJ1200
RD3	3/8-24 UNF	36	12	3.0	44AJ3803
	7/16-20 UNF	40	14	3.0	44AJ7103
	1/2-20 UNF	41	17	3.0	44AJ1203
RD4	3/8-24 UNF	36	12	4.0	44AJ3804
	7/16-20 UNF	40	14	4.0	44AJ7104
	1/2-20 UNF	41	17	4.0	44AJ1204



Подсоединитель для точки со штыком

Plug – in соединение

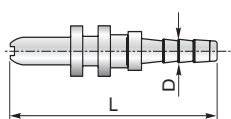

Tubo / Hose	L	D	Код/Ref.
RD2	27	2.0	33TD0000
RD3	31	3.0	33TD0003
RD4	31	4.0	33TD0004

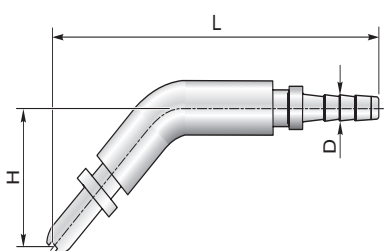

45°				
Tubo / Hose	H	L	D	Код/Ref.
RD2	24	57	2.0	33TD0040
RD3	24	59	3.0	33TD0043
RD4	24	59	4.0	33TD0044

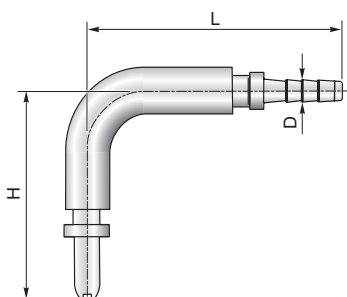

90°				
Tubo / Hose	H	L	D	Код/Ref.
RD2	28	32	2.0	33TD0090
RD3	28	36	3.0	33TD0093
RD4	28	36	4.0	33TD0094

Муфты для обжима

Ferrule

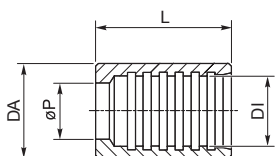

DA	DI	L	øP	ø Press	PN [bar]	Код/Ref.
8.0	5.1	15	4.5	7.1	600	30BT2000
8.0	5.1	15	4.5	7.1	600	30BT2A10*
8.0	5.7	15	4.5	7.1	600	30BT4A10*
9.0	6.5	17	6	7.6	600	30BT3000
12	9.2	17	6.5	10.2	600	30BT4000
12	9.2	17	6.5	10.2	600	30BT4A10*

INOX / Stainless steel

ø Press = Сталь, диаметр сдавливания / Crimping diameters



Цифровой манометр

Service Junior digital gauge

• Цифровой дисплей / Digital pressure measurement and display	Код/Ref.
• Точность $\pm 0,5\%$ FS / Accuracy $\pm 0,5\%$ FS	SCJN-XXX-01-MP
• Шкала измерения (bar) , гистограмма, удержание пикового давления / Display with bar graph with peak and hold function.	
• Скорость сканирования давления –10ms / Pressure peak captured –10ms scanning rate.	
• Адаптер для присоединения к точкам контроля давления M16x2 / Test point adapter M16X2.	

Диапазон измерений: 0...16bar; 0...100bar; 0...400bar; 0...600bar; 0...1000bar.

Available digital gauge range: -1...16bar; 0...100bar; 0...400bar; 0...600bar; 0...1000bar.

Переносной комплект состоящий из цифровых приборов для измерений давления

Pressure test digital kit

Комплект состоит из: / Box completed with: Dim. 385x255x90 mm	Код/Ref.
Цифровой манометр Service Junior / Digital gauge Service Junior	CBOXMEDDS
Быстро разъединяемый адаптер / Quick coupling adapters	
Адаптер штуцер-штуцер M16X2-M16X2 / Adapters male-male M16X2-M16X2	
1 Шланг M16X2- M16X2 длина 2000mm / 1 hose M16X2- M16X2 length 2000mm	
1 Адаптер гайка-штуцер M10X1- 3/8"gas / 1 Adapter female-male M10X1- 3/8"gas	
1 Адаптер гайка-штуцер M10X1-1/2"gas / 1 Adapter female-male M10X1-1/2"gas	
точка контроля 1/4" gas / Test point 1/4" gas	
точка контроля 1/8" gas / Test point 1/8" gas	
точка контроля M8X1 / Test point M8X1	
точка контроля M10X1 / Test point M10X1	





СЕРВИСМЭН ПЛЮС*

Функция "Plug & Play" с автоматическим подключением, достаточно подключить необходимый адаптер и начать измерение.
 Большой дисплей с освещением, для быстрого и легкого измерения в плохоосвещенных местах.
 Диагностика очень проста благодаря памяти мин./макс. и прямому просмотру разного давления или гидравлической подачи мощности.
 Инструкции к применению очень просты и ясны.

SERVICEMAN PLUS*

- "Plug & Play" using automatic sensor recognition, simply plug in and measure.
- Large back-lit display for quick and secure reading, even under difficult conditions.
- Simply troubleshooting using MIN/MAX memory and direct display of differential pressure or hydraulic performance.
- Simply and clear user prompts.



Датчики / Sensors



Расходомер / Flow meter

Комплект сервисмэн плюс / Kit Serviceman Plus	SCKIT-155-0-00	SCKIT-155-2-00
Чемоданчик / Device Case	1	1
Паркер Сервисмэн Плюс с ключом USB, блоком питания, соединительным кабелем для компьютера и программным обеспечением / Parker Serviceman Plus incl. USB stick, power supply, PC connection cable and SensoWin software	SCM-155-0-02-MP	SCM-155-2-05-MP
Соединительный кабель 3 метра / Analogue connection cable 3 m	2	-
Соединительный кабель CAN / Connection cable CAN	-	2
Дистрибьютор на Y / Y-distributor CAN	-	1
Резистор закрытия CAN / Final resistance CAN	-	1
Адаптер (M16x2 внешний- M16x2 внешний) / Adapter (M16x2 external - M16x2 external)	2	2
Гибкий шланг для измерения от 1500 мм. (M16x2) / Measurement tube 1.500 mm (M16x2)	2	2

* Доступные в аналоговом или шину CAN, любые датчики и расходомеры, которые будут добавлены к основному набору.

* Available in CAN Bus or analogic version, sensors and flow meters to be added to basis kit.



Портативный переносной инструмент для контроля давления
Portable hydraulic instruments for pressure testing



Тест-наборы сделаны для подключения к любому гидравлическому оборудованию со стандартными резьбовыми соединениями тест М 16х2 .

Манометры оснащены трубкой Бурдона и жидкостью (глицерин 99,7%), в соответствии с DIN 16005.

Ø 100 mm точность 1%. Ø

63 mm точность 1.6%.

Каждый комплект поставляется с двухметровым шлангом подключения

Test kits are made for connecting any hydraulic equipment with standard threaded test couplings M 16x2 and fitted micro-hose.

Pressure gauges are fitted with a Bourdon spring and liquid filled (glycerine 99.7%), according to DIN 16005.

Ø 100 mm accuracy 1%.

Ø 63 mm accuracy 1.6%.

Each kit is supplied with a 2 metre micro hose and gauges chosen from these ranges, in bar:

- 1...0 - 0,6 - 1 - 1,6 - 2,5 - 4 - 6 - 10 - 16 - 25 - 40 - 60 - 100 - 160 - 250 - 315 - 400 - 600 - 1000.



3 манометра корпус нержавеющей сталь

3 pressure gauges stainless steel housing

Диаметр 63 mm
Размеры 320x280xh119 mm

Код/Ref.
СВОХМЕД3

4 манометра корпус нержавеющей сталь

4 pressure gauges stainless steel housing

Диаметр 63 mm
Размеры 320x280xh119 mm

Код/Ref.
СВОХМЕД4





5 манометров корпус нержавеющая сталь

5 pressure gauges brass housing

2 Диаметр 100 мм	Код/Ref.
3 Диаметр 63 мм	CBOXGRA5
Размеры 430x320xh120 мм	

7 манометров корпус нержавеющая сталь

7 pressure gauges stainless steel housing

Диаметр 63 мм	Код/Ref.
Размеры 430x320xh120 мм	CBOXGRA7



Переносной сборный комплект для измерения давления

Modular portable pressure test kit



Чемодан состоящий из diam. 63 мм.и/или 100 мм. diam. 385 x 225x 90 mm : / Box completed with: Diam. 63 mm e/o 100 mm and Dim. 385x255x90 mm	CBOXMEDS1
Микро шланг соединителя F16x2-F16x2 L.2000 mm / Fitted micro-hose F16x2-F16x2 L.2000mm	1
Прямой соединитель манометра 1/4" / Direct gauge connection 1/4"	1
Соединитель Манометра 1/4 Bsp / Direct gauge connection 1/4" BSP	1
Точка для измерения давления с поршнем 1/4" BSP / Poppet Valve Test point 1/4" BSP	1
Точка для измерения давления с поршнем 1/4 - 18 NPTF / Poppet Valve Test point 1/4" - 18NPTF	1
Точка для измерения давления с поршнем M8x1 / Poppet Valve Test point M8x1	1
Точка для измерения давления с поршнем M14x1,5 / Poppet Valve Test point M14x1,5	1
Точка для измерения давления с поршнем 7/16" - 20UNF / Poppet Valve Test point 7/16" - 20UNF	1
Ридуктор F M10x1- M ISO228 G3/8" / Reducing adaptor F M10X1 - M ISO228 G3/8"	1
Ридуктор F M10x1- M ISO228 G1/2" / Reducing adaptor F M10X1 - M ISO228 G1/2"	1
Кран соединитель на 90° градусов / Anti-shock valve 90° entry	1
Кран соединитель прямой мобильный / Anti-shock valve swivel direct entry	1
Манометр Wika сталь + глицерин д. 63 вертикального соединения / Wika gauge - s/ steel+glycerine d.63 radial entry	2



Манометры заполненные глицерином
Pressure gauges stainless steel case. Glycerine filled

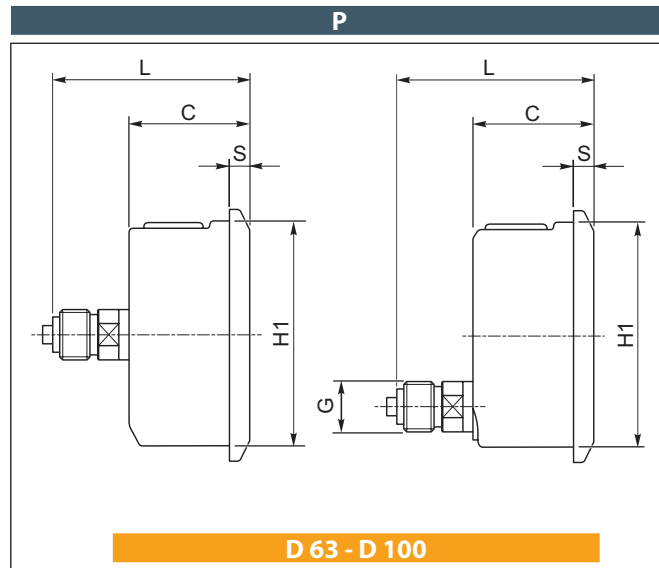
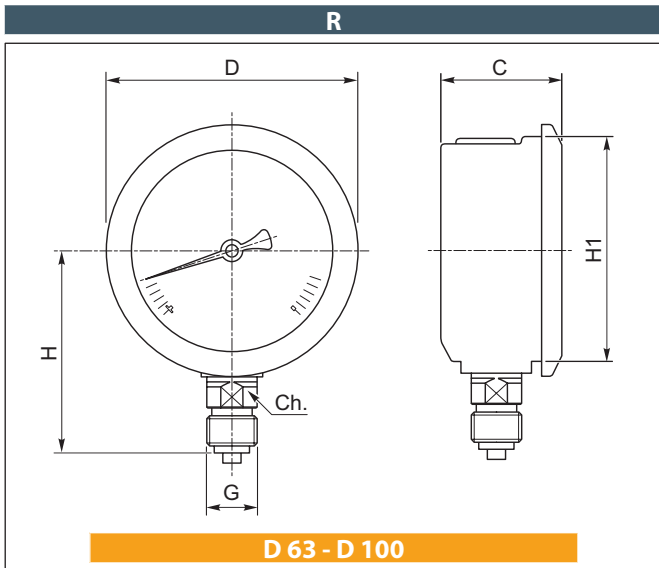

	D	G DIN 16228	H	H1	L mm	S mm	C mm	Ch mm	KI % F.S
D 63	63	G 1/4" A	54	62	56	6.5	32	14	1.6
D 100	100	G 1/2" B	87	100	81.5	8	48	22	1

D 63		
Шкала давления / Range [bar]	Код/Ref.	
-1...0	063.V01R	063.V01P
0...0.6	063.V06R	063.V06P
0...1	063.001R	063.001P
0...1.6	063.V16R	063.V16P
0...2.5	063.V25R	063.V25P
0...4	063.004R	063.004P
0...6	063.006R	063.006P
0...10	063.010R	063.010P
0...16	063.016R	063.016P
0...25	063.025R	063.025P
0...40	063.040R	063.040P
0...60	063.060R	063.060P
0...100	063.100R	063.100P
0...160	063.160R	063.160P
0...250	063.250R	063.250P
0...315	063.315R	063.315P
0...400	063.400R	063.400P
0...600	063.600R	063.600P
0...1000	063.M00R	063.M00P

D 100		
Шкала давления / Range [bar]	Код/Ref.	
-1...0	100.V01R	100.V01P
0...0.6	100.V06R	100.V06P
0...1	100.001R	100.001P
0...1.6	100.V16R	100.V16P
0...2.5	100.V25R	100.V25P
0...4	100.004R	100.004P
0...6	100.006R	100.006P
0...10	100.010R	100.010P
0...16	100.016R	100.016P
0...25	100.025R	100.025P
0...40	100.040R	100.040P
0...60	100.060R	100.060P
0...100	100.100R	100.100P
0...160	100.160R	100.160P
0...250	100.250R	100.250P
0...315	100.315R	100.315P
0...400	100.400R	100.400P
0...600	100.600R	100.600P
0...1000	100.M00R	100.M00P



защита контрольно-измерительного оборудования от гидроударов

Anti-shock valve swivel straight connection

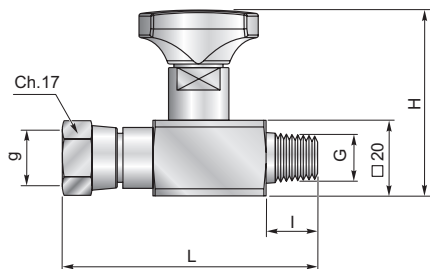

G	g	H	L	I	PN [bar]	Код/Ref.
ISO 7/1 R 1/4"	ISO 228 G1/4"	50	60	14	400	ES 180

защита контрольно-измерительного оборудования от гидроударов

Anti-shock valve double swivel straight connection

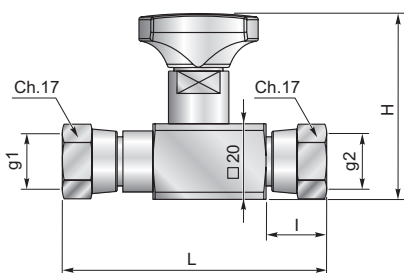

g1	g2	H	L	I	PN [bar]	Код/Ref.
ISO 228 G1/4"	ISO 228 G1/4"	50	60	14	400	ES 18G

защита контрольно-измерительного оборудования от гидроударов

Anti-shock valve fixed straight connection

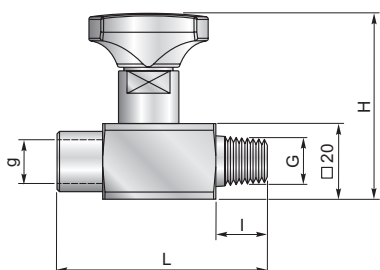

G	g	H	L	I	PN [bar]	Код/Ref.
ISO 7/1 R 1/4"	ISO 228 G1/4"	50	58	14	400	ES 18F
ISO 7/1 R 1/4"	ISO 7/1 R 1/4"	50	58.5	14	400	ES 18FR



Защита манометров от гидроударов
Pressure gauge anti-shock valves



защита контрольно-измерительного оборудования от гидроударов

Anti-shock valve 90° connection

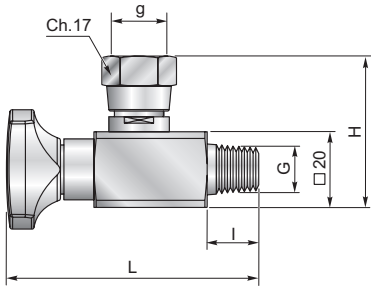

G	g	H	L	I	PN [bar]	Код/Ref.
ISO 7/1 R 1/4"	ISO 228 G1/4"	40	68	14	400	ES 090

защита контрольно-измерительного оборудования от гидроударов

Anti-shock valve 90° double swivel connection

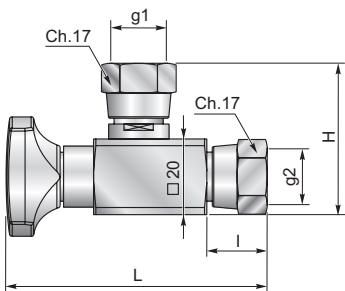

g1	g2	H	L	I	PN [bar]	Код/Ref.
ISO 228 G1/4"	ISO 228 G1/4"	40	68	14	400	ES 09G

защита контрольно-измерительного оборудования от гидроударов

Anti-shock valve fixed 90° connection

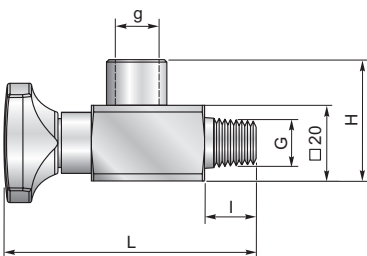

G	g	H	L	I	PN [bar]	Код/Ref.
ISO 7/1 R 1/4"	ISO 228 G1/4"	40	68	14	400	ES 09F



Гамма / Range	Характеристики / Features
16 LPM 30 LPM 60 LPM 120 LPM 180 LPM	Давление 420 bar (6000 psi) / Pressure 420 bar (6000 psi) Точность полной шкалы в пределах 4% / Accuracy within 4% fsd
200 LPM 300 LPM 400 LPM	Давление 280 bar (4000 psi) / Pressure 280 bar (4000 psi) Точность полной шкалы в пределах 4% / Accuracy within 4% fsd

Непрерывный мониторинг количества потока жидкости.
Четкий дисплей 63mm диаметр. позволяет быстро определять и контролировать производительность насоса и настройку клапана
Могут быть использованы в мобильных и промышленных системах гидравлики а так же для систем охлаждения, смазки и водно-масляных эмульсий
Индикатор может устанавливаться во взрывоопасных зонах
Позволяет одновременно контролировать: производительность насоса, рабочее давление и температуру рабочей жидкости

Flow indicators are designed for continuous monitoring or intermittent use commissioning.

The large clear 63mm diameter dial ensure that quick checks can be made to determine pump performance and setting of flow control valves.

They can be used on mobile and industrial hydraulic circuits. Also lubrication and coolant system using oil/water.

These direct acting flow indicators can be installed in hazardous areas or on applications where no power is available.

Moreover it is possible to check the temperature by the thermometer and the pressure by the predisposition for the connection with a 1/4" G test coupling.



Lined area for notes with horizontal orange lines and a decorative orange wave graphic on the left side.





Note

Notes

